



EDITION PRO Papierrollenhalter mit Deckel - Chrom gebürstet

83 510 626



- Breite 150 mm
- Höhe 95 mm
- Rosette Ø 40 mm
- Ausladung 40 mm

	Chrom gebürstet	83 510 626-93
	Chrom	83 510 626-00
	Schwarz matt	83 510 626-33

EDITION PRO Papierrollenhalter mit Deckel - Chrom gebürstet

83 510 626

mm [inches]

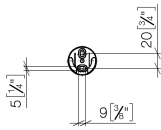
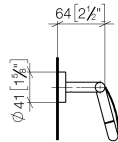
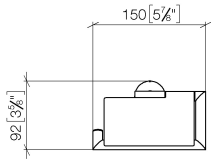

EDITION PRO Papierrollenhalter mit Deckel - Chrom gebürstet

83 510 626

Ersatzteile für die
anderen
Oberflächenvarianten
finden Sie hier:
Chrom

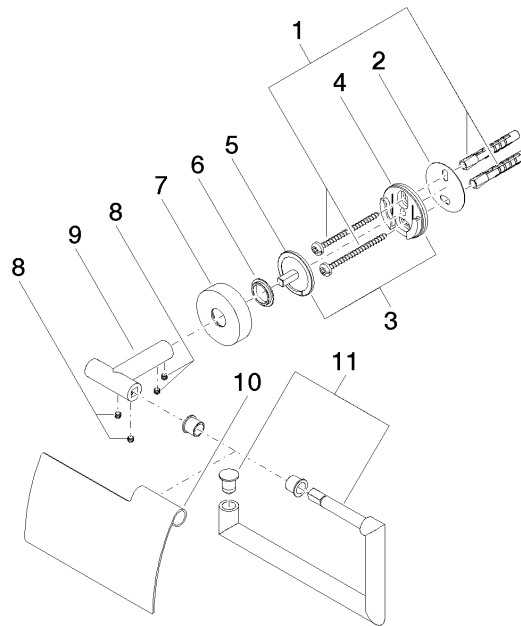

Ersatzteilstückliste

Nr.	Artikelnummer	Benennung	Verbaumenge	Lieferzeit
1	05 30 31 025 00 90	Befestigungssatz	1	2
2	05 30 11 519 00 90	Scheibe	1	2
3	05 17 97 501 01 90	Befestigungssatz	1	2
4	08 17 97 501 07	Halter	1	2
5	08 17 97 559 90	Halter	1	2
6	08 30 11 516 90	Ring	1	2
7	08 27 97 500-93	Rosette	1	20
8	90 31 11 038 00 90	Stift	4	2
9	05 17 97 562 01-93	Halter	1	20
10	08 11 02 514-93	Deckel	1	20
11	90 28 22 628 00-93	Halter	1	20