





ST 050 200 1360



- Wandrohr mit Schieber
- Rohrdurchmesser 18 mm
- Rosette Ø 60 mm
- Stichmaß 850 mm
- Metallbrauseschlauch 1750 mm mit integriertem Verdreherschutz
- Brauseschlauchanschluss 1/2"
- COMPACT RAIN, Durchfluss max. 9 l/min (bei 3 Bar)
- Brausekopf Ø 64 mm
- Dieses Produkt leistet einen Beitrag zur Erfüllung der Vorgaben von nachhaltigen Gebäudezertifizierungen, z.B. LEED®, BREEAM®, DGNB

	Platin gebürstet	ST 050 200 1360-06
	Chrom	ST 050 200 1360-00
	Platin	ST 050 200 1360-08
	Messing (23kt Gold)	ST 050 200 1360-09
	Messing gebürstet (23kt Gold)	ST 050 200 1360-28
	Dark Platinum gebürstet	ST 050 200 1360-99

Einzelkomponenten dieses Sets

Für dieses Set benötigen Sie folgende Komponenten



1x 28 002 970-06

















1x 26 413 360-06

ST 050 200 1360



- COMPACT RAIN, Durchfluss max. 9 l/min (bei 3 Bar)
- Funktion ab: 6 l/min
- Brausekopf Ø 64 mm
- Anschluss 1/2"

Eigensicher gegen Rückfließen.

	Platin gebürstet	28 002 970-06
	Chrom	28 002 970-00
	Chrom	28 002 970-00 0010
	Gold (23,9kt)	28 002 970-01
	Platin gebürstet	28 002 970-06 0010
	Platin	28 002 970-08
	Platin	28 002 970-08 0010
	Messing (23kt Gold)	28 002 970-09
	Messing (23kt Gold)	28 002 970-09 0010
	Messing gebürstet (23kt Gold)	28 002 970-28
	Messing gebürstet (23kt Gold)	28 002 970-28 0010
	Chrom gebürstet	28 002 970-93
	Chrom gebürstet	28 002 970-93 0010
	Dark Platin gebürstet	28 002 970-99
	Dark Platin gebürstet	28 002 970-99 0010

ST 050 200 1360

mm [inches]

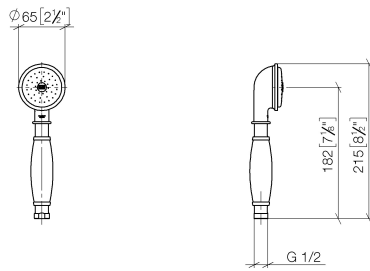

Durchflussdiagramm

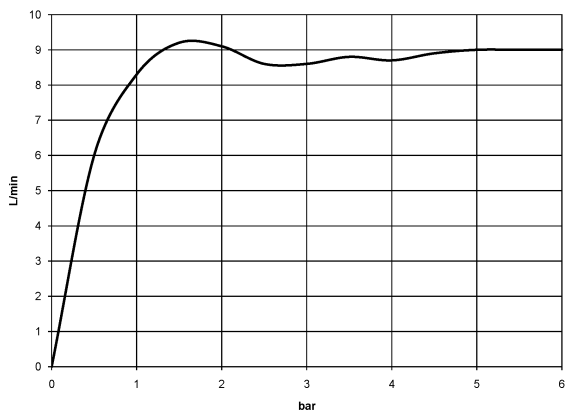

Zertifikate

LGA_8492.

WRAS_240502026.

ST 050 200 1360

Ersatzteile für die
anderen
Oberflächenvarianten
finden Sie hier:
Chrom

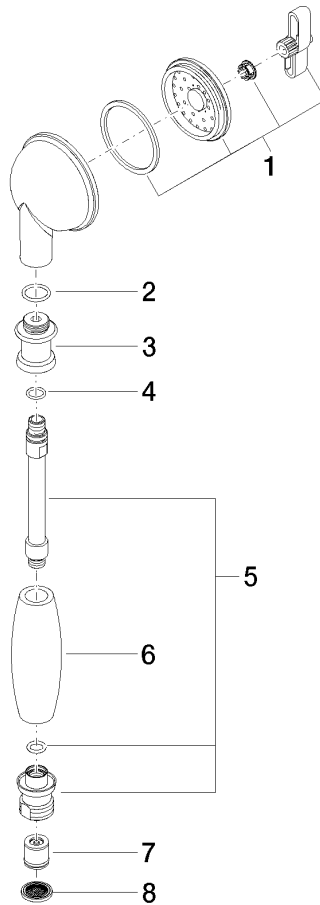

Ersatzteilstückliste

Nr.	Artikelnummer	Benennung	Verbaumenge	Lieferzeit
1	90 12 01 010 00 90	Set	1	2
2	09 14 10 069 90	Dichtung	1	2
3	09 24 04 059 20-06	Nippel	1	10
4	09 14 10 042 90	Dichtung	1	2
5	90 28 22 033 00-06	Einsatz	1	-
Ersatzteil nicht mehr bestellbar, bitte bestellen Sie den Nachfolgeartikel				
6	11 167 820 60	Griff	1	2
7	09 23 01 077 90	Durchflussbegrenzer	1	2
8	09 23 01 039 90	Sieb	1	2

ST 050 200 1360



- Wandrohr mit Schieber
- Rohrdurchmesser 18 mm
- Rosette Ø 60 mm
- Stichmaß 850 mm
- Metallbrauseschlauch 1750 mm mit integriertem Verdrehenschutz
- Brauseschlauchanschluss 1/2"

Dieser Artikel enthält keine Handbrause!

	Platin gebürstet	26 413 360-06
	Chrom	26 413 360-00
	Platin	26 413 360-08
	Messing (23kt Gold)	26 413 360-09
	Messing gebürstet (23kt Gold)	26 413 360-28
	Dark Platinum gebürstet	26 413 360-99

Empfohlenes Zubehör

- | | | |
|--|---|---------------|
| | UP-Wandwinkel - | 35 085 970 90 |
| | <ul style="list-style-type: none"> •Max. Einbautiefe 163 mm •Min. Einbautiefe 90 mm | |

Benötigtes Zubehör

- | | | |
|--|--|---------------|
| | MADISON Handbrause - Platin gebürstet | 28 002 978-06 |
| | <ul style="list-style-type: none"> •Brausekopf Ø 95 mm •Weitere Handbrausen finden Sie ab Seite {PAGE} •Dreifach verstellbar: COMPACT RAIN, COMPACT SOFT FLOW, COMPACT AQUAPRESSURE FLOW, Durchfluss max. l/min (bei 3 Bar) | |

Empfohlenes Zubehör

- | | | |
|--|--|---------------|
| | MADISON Wandanschlussbogen - Platin gebürstet | 28 450 410-06 |
|--|--|---------------|

Benötigtes Zubehör

- | | | |
|--|--|--------------------|
| | MADISON Metall-Handbrause mit Porzellangriff (weiß) FlowReduce - Platin gebürstet | 28 002 970-06 0010 |
|--|--|--------------------|

Benötigtes Zubehör

- | | | |
|--|--|--------------------|
| | MADISON Handbrause FlowReduce - Platin gebürstet | 28 002 978-06 0010 |
| | <ul style="list-style-type: none"> •Brausekopf Ø 95 mm •Weitere Handbrausen finden Sie ab Seite {PAGE} •Dreifach verstellbar: COMPACT RAIN, COMPACT SOFT FLOW, COMPACT AQUAPRESSURE FLOW, Durchfluss max. l/min (bei 3 Bar) | |

ST 050 200 1360

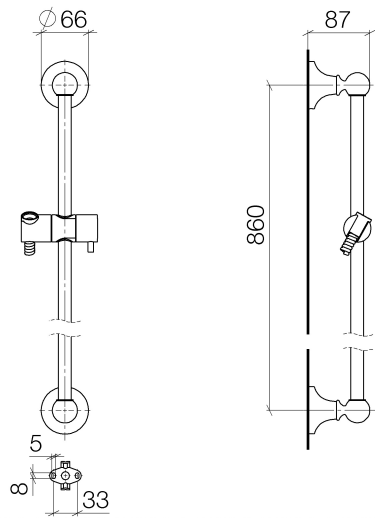

Zertifikate

WRAS_2009048. IAPMO_4976 (4).

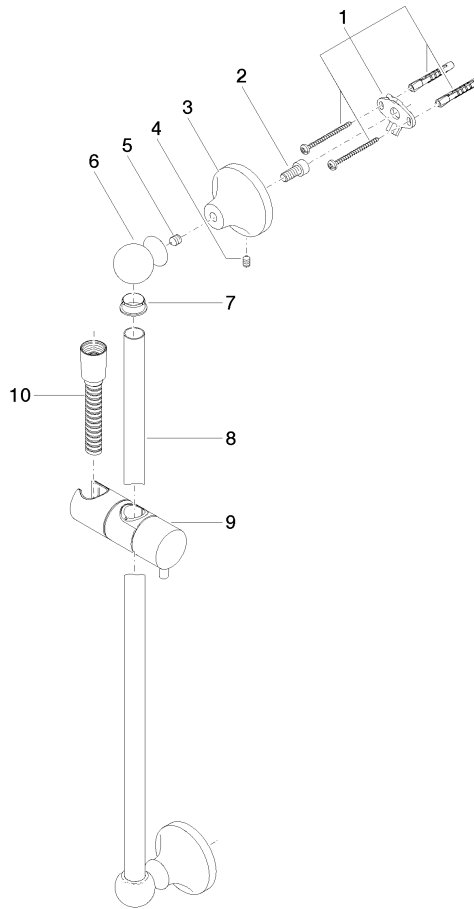

Ersatzteilstückliste

Nr.	Artikelnummer	Benennung	Verbaumenge	Lieferzeit
1	90 17 20 708 00 90	Befestigungssatz	2	2
2	09 30 30 048 90	Schraube	2	2
3	09 17 20 016-06	Halter	2	10
4	09 31 11 144 90	Stift	2	2
5	09 31 11 002 90	Stift	2	2
6	09 21 40 020-06	Anschluss	2	60
7	09 18 40 009 90	Huelse	2	2
8	08 28 22 596-06	Rohr	1	60
9	12 580 970-06	Schieber - Platin gebürstet	1	10
10	28 204 970-06	Metall-Brauseschlauch 1/2" x 1/2" x 1750 mm - Platin gebürstet	1	2