







ST 060 113 2985



- Abdeckplatte 120 x 120 mm
- Rosette 60 x 60 mm
- Skalengriff mit Sicherheitssperre bei 38°C
- Thermostat-Kartusche
- 2x Oberteil mit ablängbarer Spindel und Hülse

	Chrom	ST 060 113 2985-00
	Platin gebürstet	ST 060 113 2985-06
	Platin	ST 060 113 2985-08
	Light Gold gebürstet	ST 060 113 2985-27
	Messing gebürstet (23kt Gold)	ST 060 113 2985-28
	Chrom gebürstet	ST 060 113 2985-93
	Dark Platinum gebürstet	ST 060 113 2985-99

**Einzelkomponenten dieses Sets**

Für dieses Set benötigen Sie folgende Komponenten



1x 36 503 985-00



2x 36 607 985-00



ST 060 113 2985



- Abdeckplatte 120 x 120 mm
- Skalengriff mit Sicherheitssperre bei 38°C
- Thermostat-Kartusche

Passt zu: IMO, MEM, CL.1, CYO

	Chrom	36 503 985-00
	Platin gebürstet	36 503 985-06
	Platin	36 503 985-08
	Dark Chrome	36 503 985-19
	Light Gold gebürstet	36 503 985-27
	Messing gebürstet (23kt Gold)	36 503 985-28
	Schwarz matt	36 503 985-33
	Champagne gebürstet (22kt Gold)	36 503 985-46
	Champagne (22kt Gold)	36 503 985-47
	Chrom gebürstet	36 503 985-93
	Dark Platinum gebürstet	36 503 985-99

**Benötigtes Zubehör**



**xTOOL UP-Thermostatmodul ohne Mengenregulierung -** 35 503 970 90

- Max. Einbautiefe 160 mm
- Min. Einbautiefe 95 mm

**Benötigtes Zubehör**



**xGRID Montageschiene 555 mm -** 12 360 970 90

**Empfohlenes Zubehör**



**xGRID Befestigungssatz für die Integration in den Trockenbau -** 12 340 970 90

ST 060 113 2985

mm [inches]

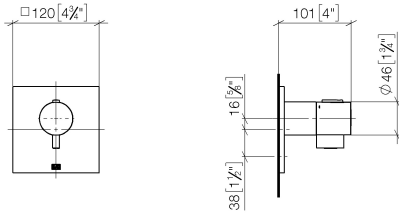

**Durchflussdiagramm**

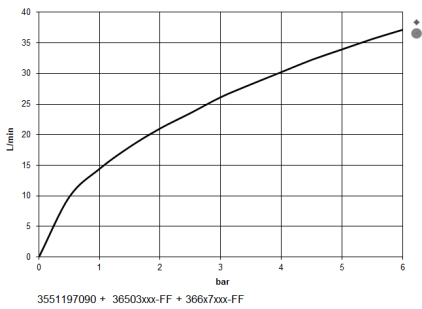

**Zertifikate**

WRAS\_2011026.

DVGW\_DW-  
6512DN0706.

LGA\_29930.

LGA\_29932.

ST 060 113 2985

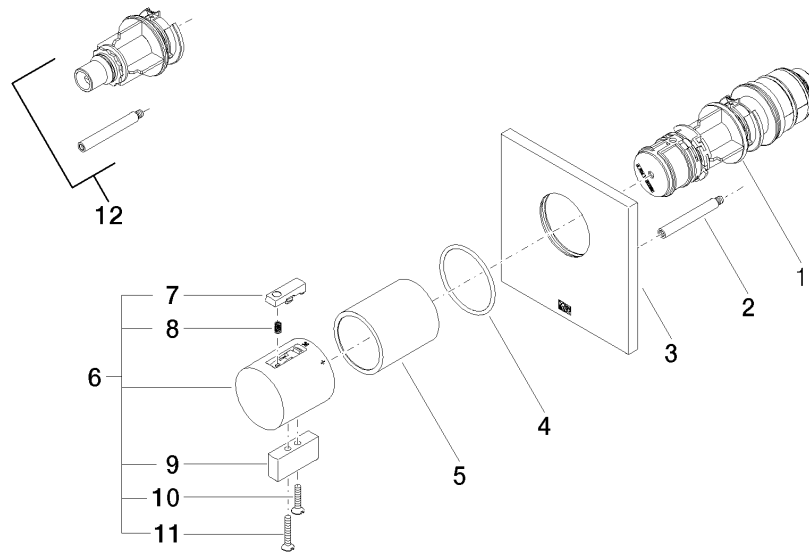







**Ersatzteilstückliste**

Nr.	Artikelnummer	Benennung	Verbaumenge	Lieferzeit
1	90 15 02 063 00 90	Kartusche	1	2
2	90 31 09 095 00 90	Stange	1	2
3	09 11 02 196-00	Abdeckung	1	60
4	90 14 10 049 00 90	Dichtung	1	2
5	90 21 02 112 00-00	Huelse	1	10
6	04 17 33 006 00-00	Griff	1	60
7	90 21 33 011 00-13	Griff	1	2
8	90 16 02 027 00 90	Feder	1	2
9	09 20 33 006-00	Griff	1	10
10	09 30 30 159-00	Schraube	1	10
11	09 30 30 160-00	Schraube	1	10
12	12 178 970 90	Verlängerung 46 mm -	1	2

ST 060 113 2985

- Rosette 60 x 60 mm
- Oberteil mit ablängbarer Spindel und Hülse



	Chrom	36 607 985-00
	Platin gebürstet	36 607 985-06
	Platin	36 607 985-08
	Light Gold gebürstet	36 607 985-27
	Messing gebürstet (23kt Gold)	36 607 985-28
	Chrom gebürstet	36 607 985-93
	Dark Platinum gebürstet	36 607 985-99

**Benötigtes Zubehör**

	<b>UP-Ventil 1/2" -</b> <ul style="list-style-type: none"> <li>•Max. Einbautiefe 145 mm</li> <li>•Min. Einbautiefe 75 mm</li> </ul>	35 607 970 90
---	--	---------------



ST 060 113 2985

mm [inches]

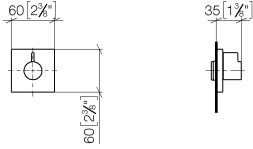

Zertifikate

DVGW_DW- 6501DN0116.	WRAS_2011026.	IAPMO_4976 (1).	LGA_29931.	WRAS_2010066.
DVGW_DW- 6512DN0706.	LGA_29932.			



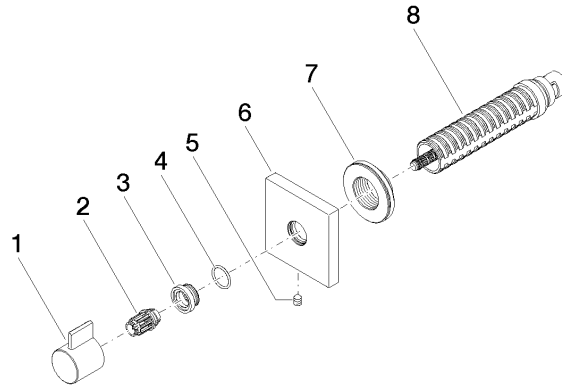

### Ersatzteilstückliste

Nr.	Artikelnummer	Benennung	Verbaumenge	Lieferzeit
1	09 20 98 002-00	Griff	1	10
2	09 12 12 005 90	Rastbuchse	1	2
3	09 12 12 043-00	Aufnahme	1	10
4	09 14 10 017 90	Dichtung	1	2
5	90 31 11 004 00 90	Stift	1	2
6	09 27 98 014-00	Rosette	1	10
7	09 21 02 151 90	Huelse	1	2
8	90 90 03 202 00 90	Oberteil	1	2