











ST 110 201 1892



- Ausladung 235 mm
- schwenkbarer Auslauf 360°
- luftangereicherter Strahl und Brausestrahl
- Armaturenhöhe 370 mm
- Höhe bis Luftsprudler 212 mm
- Bohrungsdurchmesser Auslauf 35 mm
- Bohrungsdurchmesser Seitenventil 32 mm
- Bohrungsdurchmesser Spülbrause 32 mm
- gewebeumflochtener Brauseschlauch 1500 mm
- automatischer Umschalter Auslauf/Brause
- Sprayface mit Antikalk-System
- Durchfluss max. 7 l/min bei 3 bar Fließdruck
- bleifrei
- Dieses Produkt leistet einen Beitrag zur Erfüllung der Vorgaben von nachhaltigen Gebäudezertifizierungen, z.B. LEED®, BREEAM®, DGNB

	Platin gebürstet	ST 110 201 1892-06
	Chrom	ST 110 201 1892-00
	Platin	ST 110 201 1892-08
	Messing (23kt Gold)	ST 110 201 1892-09
	Dark Chrome	ST 110 201 1892-19
	Messing gebürstet (23kt Gold)	ST 110 201 1892-28
	Schwarz matt	ST 110 201 1892-33
	Champagne gebürstet (22kt Gold)	ST 110 201 1892-46
	Champagne (22kt Gold)	ST 110 201 1892-47
	Chrom gebürstet (Edelstahl-Look)	ST 110 201 1892-93
	Dark Platinum gebürstet	ST 110 201 1892-99

**Einzelkomponenten dieses Sets**

Für dieses Set benötigen Sie folgende Komponenten



1x 20 815 892-06



1x 27 721 970-06



ST 110 201 1892



- Ausladung 235 mm
- schwenkbarer Auslauf 360°
- luftangereicherter Strahl
- Armaturenhöhe 370 mm
- Höhe bis Luftsprudler 212 mm
- Bohrungsdurchmesser Auslauf 35 mm
- Bohrungsdurchmesser Seitenventil 32 mm
- Durchfluss max. 7 l/min bei 3 bar Fließdruck
- bleifrei
- Dieses Produkt leistet einen Beitrag zur Erfüllung der Vorgaben von nachhaltigen Gebäudezertifizierungen, z.B. LEED®, BREEAM®, DGNB

	Platin gebürstet	20 815 892-06
	Chrom	20 815 892-00
	Platin	20 815 892-08
	Messing (23kt Gold)	20 815 892-09
	Dark Chrome	20 815 892-19
	Messing gebürstet (23kt Gold)	20 815 892-28
	Schwarz matt	20 815 892-33
	Champagne gebürstet (22kt Gold)	20 815 892-46
	Champagne (22kt Gold)	20 815 892-47
	Chrom gebürstet (Edelstahl-Look)	20 815 892-93
	Dark Platin gebürstet	20 815 892-99

**Empfohlenes Zubehör**

**Exzenterbetätigung mit Drehknopf - Platin gebürstet** 10 710 970-06



**Empfohlenes Zubehör**

**Spender mit Rosette - Platin gebürstet** 82 444 970-06



ST 110 201 1892

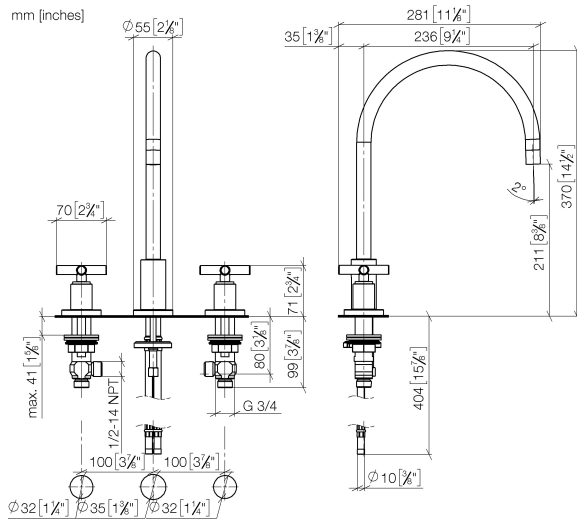

**Durchflussdiagramm**

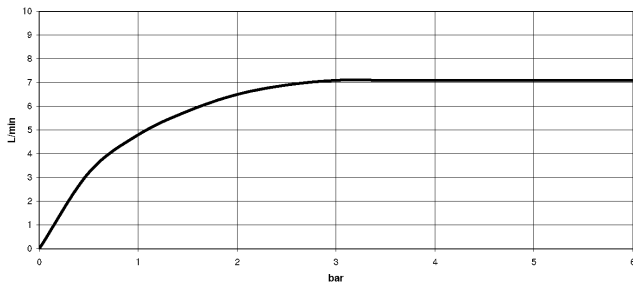

**Zertifikate**

WRAS\_2107052.

ETA\_18514.

LGA\_19166.

GDV\_0400289.

ST 110 201 1892

Ersatzteile für die  
anderen  
Oberflächenvarianten  
finden Sie hier:  
Chrom

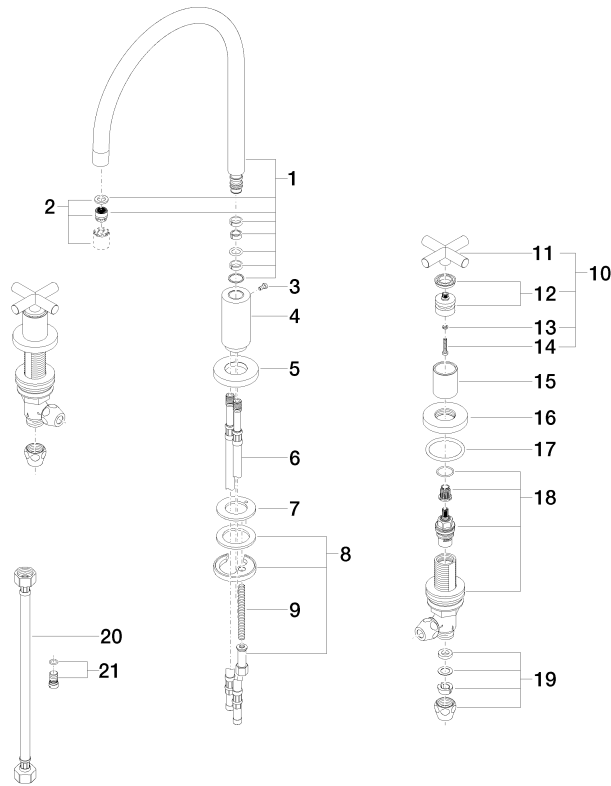

**Ersatzteilstückliste**

Nr.	Artikelnummer	Benennung	Verbaumenge	Lieferzeit
1	90 28 22 226 01-06	Auslauf	1	10
2	90 23 01 028 03-06	Luftsprudler	1	10
3	09 30 30 057 90	Schraube	1	2
4	09 11 10 088 10-06	Anschluss	1	10
5	09 28 10 140-06	Ring	1	10
6	04 30 04 064 00 90	Schlauch	2	60
7	09 14 05 047 90	Dichtung	1	2
8	04 30 11 038 00 90	Befestigungssatz	1	2
9	09 31 11 011 90	Stift	1	2
10	90 20 89 010 10-06	Griff	2	10
11	09 20 89 010-06	Griff	2	60
12	90 12 12 007 00-06	Aufnahme	2	10
13	90 30 11 029 00 90	Scheibe	2	2
14	90 30 30 075 00 90	Schraube	2	2
15	09 21 02 140-06	Huelse	2	10
16	09 27 89 105-06	Rosette	2	10
17	90 14 10 043 00 90	Dichtung	2	2
18	90 17 11 040 51 90	Seitenteil	2	2
19	90 23 30 040 00-06	Verschraubung	4	10
20	12 501 970 90	Druckschlauch 1/2" x 1/2" x 300 mm -	2	-
Ersatzteil nicht mehr bestellbar, bitte bestellen Sie den Nachfolgeartikel				
21	04 31 20 046 10 92	Set	1	2

ST 110 201 1892



Passt zu: ELIO, TARA, TARA ULTRA

- mit runder Rosette
- Brausestrahl
- automatischer Umschalter Auslauf/Brause
- Armaturenhöhe 191 mm
- Bohrungsdurchmesser Spülbrause 32 mm
- gewebeumflochtener Brauseschlauch 1500 mm
- Sprayface mit Antikalk-System
- bleifrei

Nur kombinierbar mit 33826790, 32800790, 33826888, 32815888, 20815892, 33826875.

Eigensicher gegen Rückfließen.

	Platin gebürstet	27 721 970-06
	Chrom	27 721 970-00
	Platin	27 721 970-08
	Messing (23kt Gold)	27 721 970-09
	Dark Chrome	27 721 970-19
	Messing gebürstet (23kt Gold)	27 721 970-28
	Schwarz matt	27 721 970-33
	Champagne gebürstet (22kt Gold)	27 721 970-46
	Champagne (22kt Gold)	27 721 970-47
	Chrom gebürstet (Edelstahl-Look)	27 721 970-93
	Dark Platinum gebürstet	27 721 970-99



ST 110 201 1892

mm [inches]

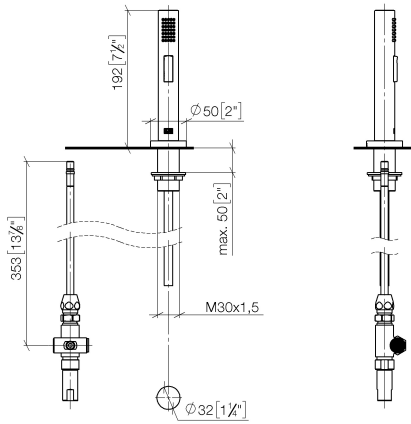

**Durchflussdiagramm**

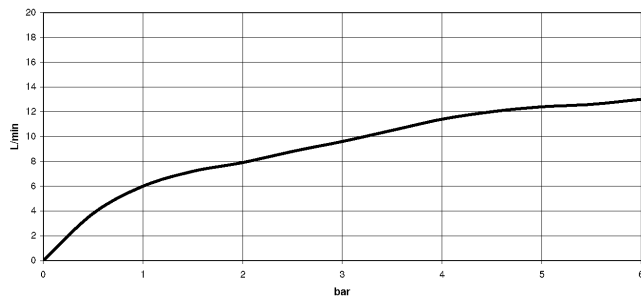

**Zertifikate**

LGA\_18901.      Belgaqua\_21-027-27\_3.      IAPMO\_N-4976 (2).      LGA\_29572.      IAPMO\_6397.



ST 110 201 1892

Ersatzteile für die  
anderen  
Oberflächenvarianten  
finden Sie hier:  
Chrom

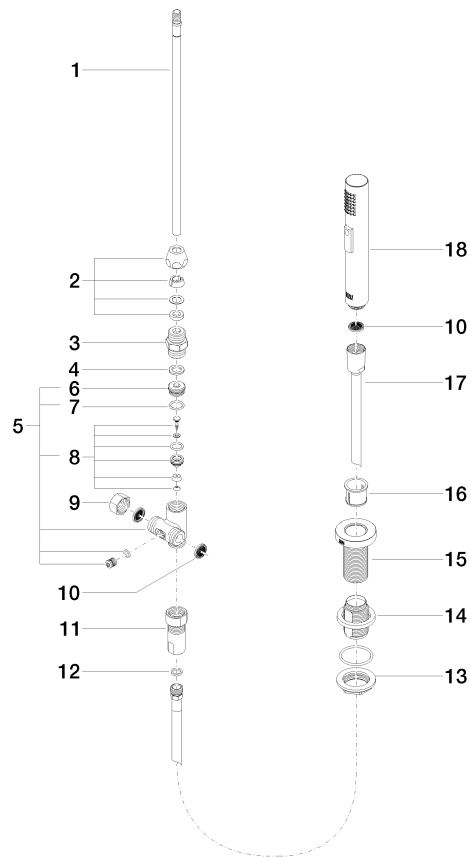

### Ersatzteilstückliste

Nr.	Artikelnummer	Benennung	Verbaumenge	Lieferzeit
1	04 24 02 046 01-07	Rohr	1	10
2	90 23 30 040 00-06	Verschraubung	1	10
3	90 24 03 168 00 90	Nippel	1	2
4	90 14 20 002 00 90	Dichtung	1	2
5	90 17 09 046 10 90	Umstellung	1	2
6	09 24 04 112 10 90	Nippel	1	2
7	90 14 10 033 00 90	Dichtung	1	2
8	90 21 10 031 10 90	Umstellung	1	2
9	04 21 02 006 00 92	Kappe	1	2
10	09 23 01 039 90	Sieb	2	2
11	90 24 03 241 00 90	Nippel	1	2
12	90 14 20 019 00 90	Dichtung	1	2
13	04 30 11 038 66 90	Befestigungssatz	1	2
14	12 720 970 90	Verlängerungsset -	1	60
15	09 30 01 285-06	Rosette	1	10
16	90 18 40 085 00 90	Huelse	1	2
17	90 30 02 062 00-06	Schlauch	1	10
18	04 12 11 158 00-06	Brause	1	10