













13 415 979



- saillie 150 mm
- CASCADE, débit max. 26,5 l/min (à 3 bar)
- plaque de recouvrement 240 x 60 mm
- raccord 1/2"
- montage de la fiche

S'adapte aux gammes suivantes : IMO, LULU, MADISON, MEM, TARA, CL.1, LISSÉ, VAIA, META, CYO

	Or clair	13 415 979-26
	Chrome	13 415 979-00
	Platine brossé	13 415 979-06
	Platine	13 415 979-08
	Dark Chrome	13 415 979-19
	Or clair brossé	13 415 979-27
	Laiton brossé (Or 23cts)	13 415 979-28
	Noir mat	13 415 979-33
	Bronze brossé	13 415 979-42
	Champagne brossé (Or 22cts)	13 415 979-46
	Champagne (Or 22cts)	13 415 979-47
	Chrome brossé	13 415 979-93
	Dark Platinum brossé	13 415 979-99

Accessoires recommandés



Coude mural à encastrer - 35 085 970 90
 ●profondeur de montage mini. 90 mm
 ●profondeur de montage max. 163 mm

Accessoires recommandés



Coude mural à encastrer - 35 085 970 90
 ●profondeur de montage mini. 90 mm
 ●profondeur de montage max. 163 mm

13 415 979

mm [inches]



Diagramme de débit



Diagramme de portée du jet

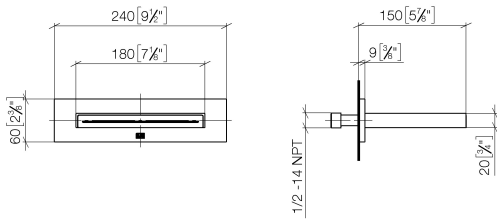

Certificats

WRAS_2306001.

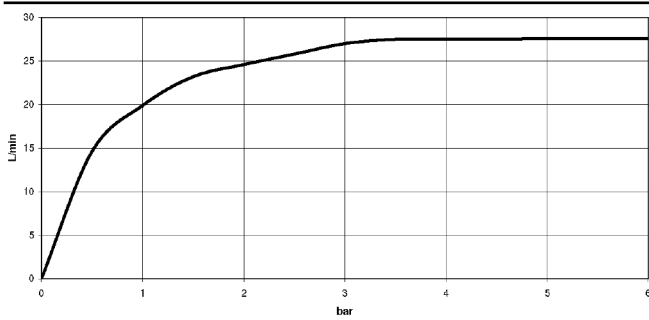
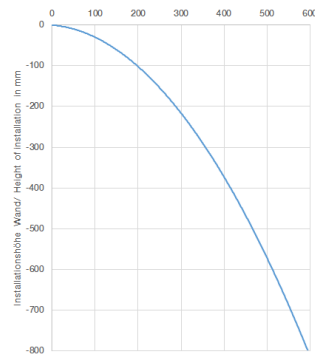
13 415 979

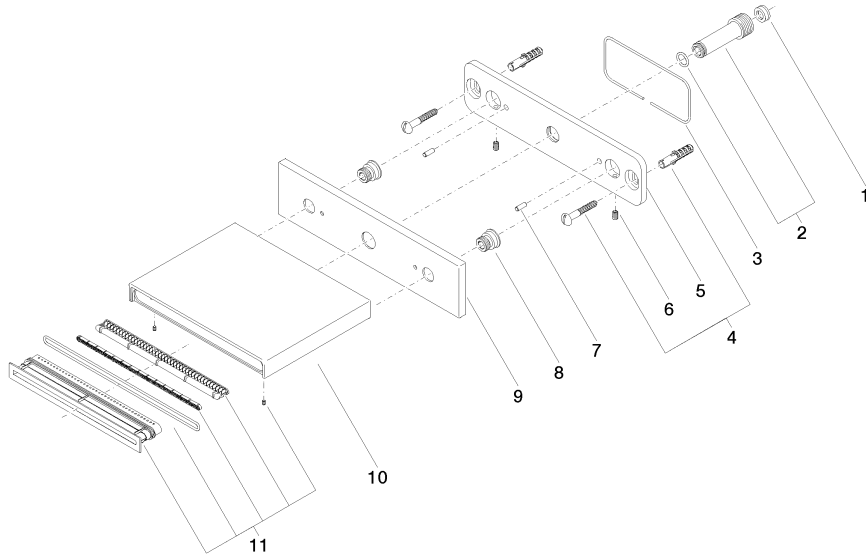

Liste des pièces de rechange

N°	Article Numéro	Désignation	Fréquence de montage	Délai de livraison
1	09 23 01 057 90	limitateur de débit	1	2
2	90 24 03 213 00 90	raccord	1	2
3	09 14 03 134 90	joint	1	2
4	04 30 31 024 01 90	set de fixation	1	2
5	09 17 97 059 90	patte de fixation	1	2
6	09 31 11 036 90	tige	2	2
7	09 31 11 040 90	tige	2	2
8	09 24 03 214 90	raccord à vis	2	2
9	09 27 78 031-26	rosace	1	60
10	09 11 78 003 20-26	bec déverseur	1	60
11	90 29 03 059 00 90	élément insérable	1	2