







20 004 715

- diamètre de percement 32 mm
- rosace 60 x 47 mm
- avec marquage chaud



S'adapte aux gammes suivantes : CL.1, CYO

	Platine brossé	20 004 715-06
	Chrome	20 004 715-00
	Laiton brossé (Or 23cts)	20 004 715-28
	Champagne brossé (Or 22cts)	20 004 715-46
	Champagne (Or 22cts)	20 004 715-47
	Dark Platinum brossé	20 004 715-99

20 004 715

mm [inches]

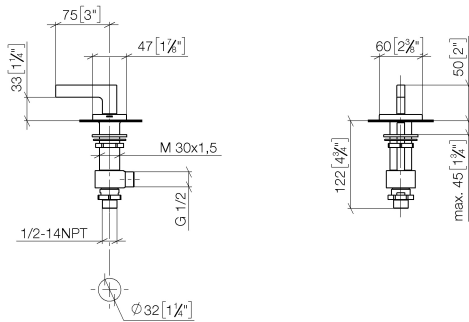

**Diagramme de débit**

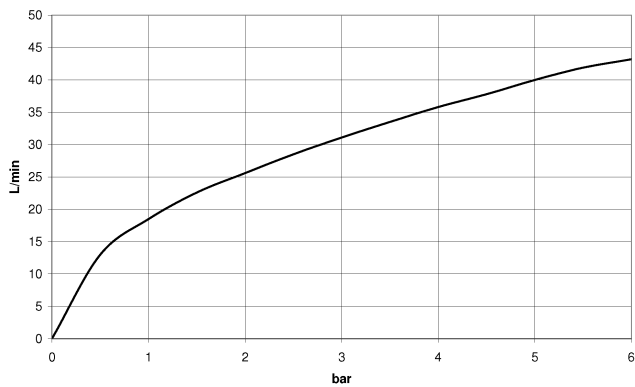

**Certificats**

IAPMO\_4976 (5).    IAPMO\_N-4976.    LGA\_28687.    IAPMO\_6397.

20 004 715

Les pièces pour les autres finitions peuvent être trouvées ici : [Chrome](#)

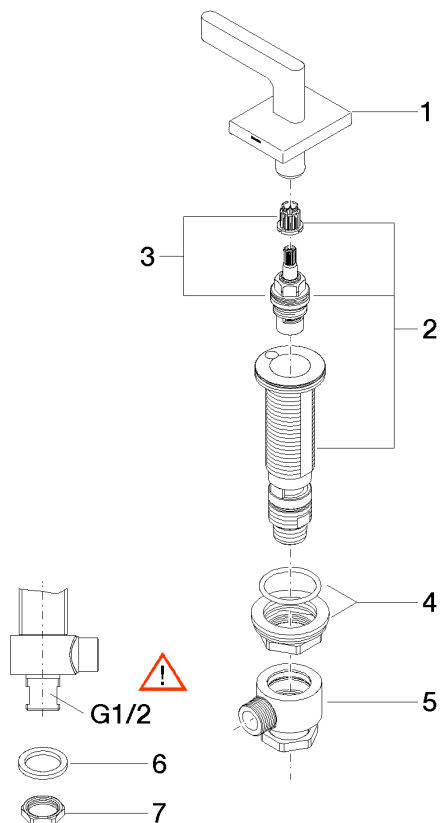

### Liste des pièces de rechange

N°	Article Numéro	Désignation	Fréquence de montage	Délai de livraison
1	90 20 70 057 02-06	poignée ( hot )	1	10
2	04 17 11 058 53 90	partie latérale	1	2
3	90 90 03 153 00 90	tête céramique	1	2
4	04 23 10 032 78 90	set de fixation	1	2
5	04 17 11 023 10 90	raccord multiple	1	2
6	09 30 11 059 90	rondelle	1	2
7	09 23 10 012 90	écrou	1	2