









**VAIA Mélangeur de lavabo monotrou avec tube vertical sans garniture  
d'écoulement - Dark Chrome**

VAIA

22 585 809



- saillie 202 mm
- bec pivotant 360°
- jet circulaire enrichi en air
- hauteur totale 1251 - 1321 mm
- hauteur jusqu'au mousseur 1152 – 1222 mm
- rosace Ø 135 mm
- débit maxi. 5,7 l/min
- sans plomb
- Ce produit contribue au respect des exigences des systèmes d'évaluation des bâtiments écologiques, par exemple LEED®, BREEAM®, DGNB

	Dark Chrome	22 585 809-19
	Chrome	22 585 809-00
	Platine brossé	22 585 809-06
	Platine	22 585 809-08
	Laiton brossé (Or 23cts)	22 585 809-28
	Bronze brossé	22 585 809-42
	Champagne brossé (Or 22cts)	22 585 809-46
	Champagne (Or 22cts)	22 585 809-47
	Dark Platinum brossé	22 585 809-99

**Accessoires requis**



- Fixation au sol à encastrer - 35 945 970 90**
- profondeur de montage max. 150 mm
  - profondeur de montage mini. 80 mm

**VAIA Mélangeur de lavabo monotrou avec tube vertical sans garniture  
d'écoulement - Dark Chrome**

VAIA

22 585 809  
mm [inches]

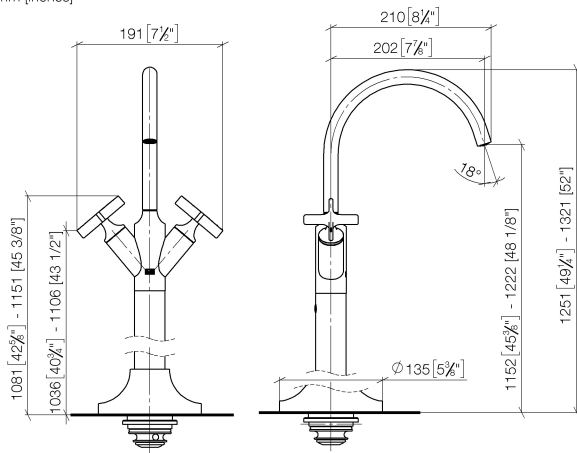

**Diagramme de débit**



**Certificats**

LGA\_38416.

WRAS\_240102001.

22 585 809

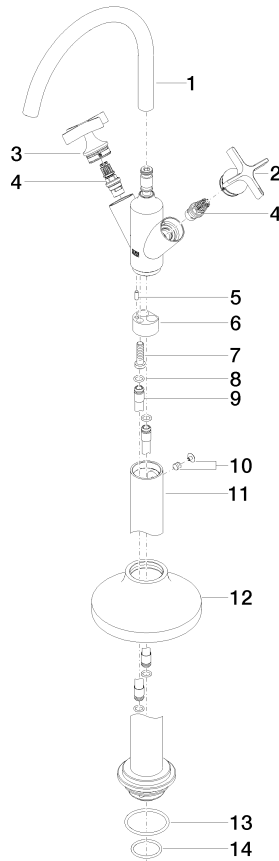

## Liste des pièces de rechange

N°	Article Numéro	Désignation	Fréquence de montage	Délai de livraison
1	90 28 22 313 00-19	bec déverseur	1	20
2	90 20 66 028 00-19	poignée ( cold )	1	20
3	90 20 66 029 01-19	poignée ( hot )	1	20
4	90 90 03 175 00 90	tête céramique	2	2
5	09 31 11 040 90	tige	1	2
6	09 24 03 193 90	adaptateur	1	2
7	09 30 30 047 90	vis	1	2
8	09 14 10 139 90	joint	4	2
9	04 28 22 022 10 90	raccord	2	2
10	04 31 11 002 00 90	tige	1	2
11	04 28 22 028 00-19	tuyau	1	60
12	90 27 80 033 00-19	rosace	1	20
13	09 14 10 084 90	joint	1	2
14	09 14 10 018 90	joint	1	2