

26 413 892



- barre de douche avec curseur
- diamètre de tube 18 mm
- rosaces Ø 55 mm
- entraxe 800 mm
- flexible de douche métallique 1750 mm avec protection anti-torsion intégrée
- raccord de flexible de douche 3/8"

Cet article ne comprend pas de douchette à main !

	Noir mat	26 413 892-33
	Chrome	26 413 892-00
	Platine brossé	26 413 892-06
	Platine	26 413 892-08
	Dark Chrome	26 413 892-19
	Laiton brossé (Or 23cts)	26 413 892-28
	Bronze brossé	26 413 892-42
	Champagne brossé (Or 22cts)	26 413 892-46
	Champagne (Or 22cts)	26 413 892-47
	Chrome brossé	26 413 892-93
	Dark Platinum brossé	26 413 892-99

26 413 892

Accessoires recommandés

	<b>Coude mural à encastrer -</b> ●profondeur de montage max. 163 mm ●profondeur de montage mini. 90 mm	35 085 970 90
---	--	---------------

Accessoires requis

	<b>Douchette à main FlowReduce -</b> <b>Noir mat</b>	28 016 979-33 0010
---	---	-----------------------

Accessoires requis

	<b>Douchette à main FlowReduce -</b> <b>Noir mat</b>	28 012 979-33 0010
---	---	-----------------------

Accessoires requis

	<b>Douchette à main - Noir mat</b>	28 012 979-33
---	------------------------------------	---------------

Accessoires requis

	<b>Douchette à main FlowReduce -</b> <b>Noir mat</b>	28 018 979-33 0010
---	---	-----------------------

Accessoires requis

	<b>ARTICLES GÉNÉRIQUES</b> <b>Douchette à main - Noir mat</b>	28 029 979-33
---	--	---------------

Accessoires requis

	<b>ARTICLES GÉNÉRIQUES</b> <b>Douchette à main - Noir mat</b>	28 025 979-33 0010
---	--	-----------------------

Accessoires recommandés

	<b>Coude mural - Noir mat</b>	28 450 625-33
---	-------------------------------	---------------

Accessoires requis

	<b>Douchette à main - Noir mat</b>	28 017 979-33
---	------------------------------------	---------------

Accessoires requis

	<b>Douchette à main - Noir mat</b>	28 016 979-33
---	------------------------------------	---------------

Accessoires requis

	<b>Douchette à main - Noir mat</b>	28 018 979-33
---	------------------------------------	---------------

Accessoires requis

	<b>ARTICLES GÉNÉRIQUES</b> <b>Douchette à main - Noir mat</b>	28 029 979-33 0010
---	--	-----------------------

Accessoires requis

	<b>ARTICLES GÉNÉRIQUES</b> <b>Douchette à main - Noir mat</b>	28 027 979-33 0010
---	--	-----------------------

26 413 892

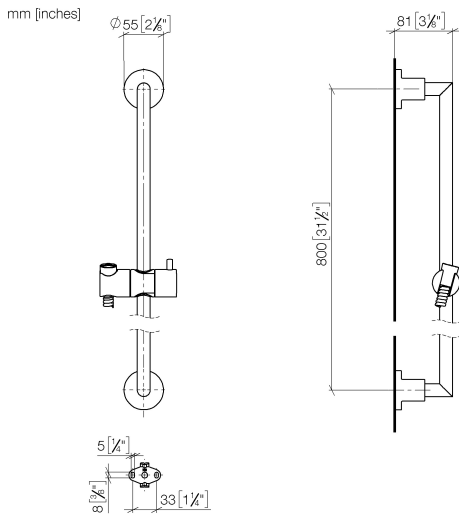

Codes & Standards

ASME A112.18.1

cUPC

Scottish Water  
Byelaws

UK Water Supply  
Regulations

XP P 41-280

Certificats

IAPMO\_4976

WRAS\_2009

ACS\_20 ACC LY

26 413 892

Version du produit de 4/1/2024

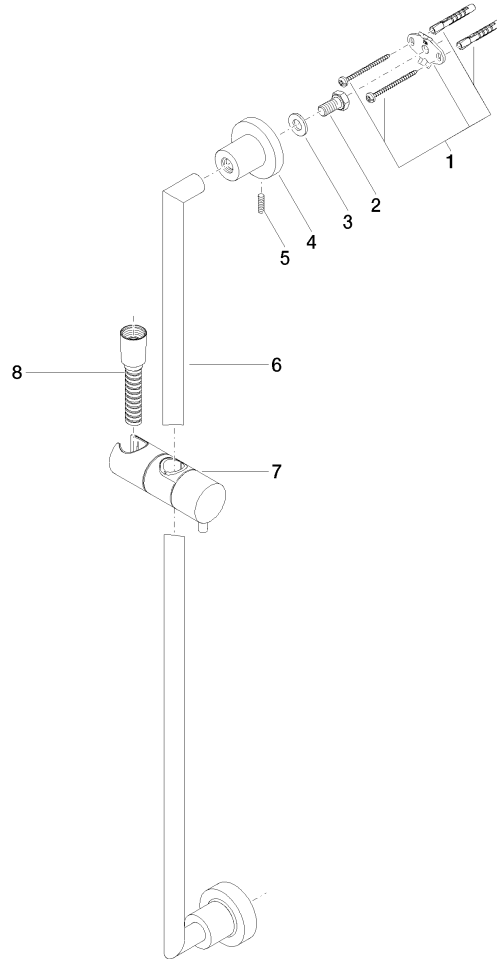



TARA Garniture de douche sans douchette - Noir mat

TARA

26 413 892

**Liste des pièces de rechange**

**Version du produit de 4/1/2024**

N°	Article Numéro	Désignation	Fréquence de montage	Délai de livraison
	05 17 20 739 00 90	set de fixation	13	2