















28 002 978



- 3 jets réglables : COMPACT RAIN, COMPACT SOFT FLOW, COMPACT AQUAPRESSURE FLOW, débit max. 6,8 l/min (à 3 bar)
- avec système anti-calcaire
- pomme de douche Ø 95 mm
- raccord 1/2"
- Ce produit contribue au respect des exigences des systèmes d'évaluation des bâtiments écologiques, par exemple LEED®, BREEAM®, DGNB

Avec sécurité anti-retour.

	Laiton brossé (Or 23cts)	28 002 978-28 0010
	Chrome	28 002 978-00
	Chrome	28 002 978-00 0010
	Platine brossé	28 002 978-06
	Platine brossé	28 002 978-06 0010
	Platine	28 002 978-08
	Platine	28 002 978-08 0010
	Laiton (Or 23cts)	28 002 978-09
	Laiton (Or 23cts)	28 002 978-09 0010
	Laiton brossé (Or 23cts)	28 002 978-28
	Chrome brossé	28 002 978-93
	Chrome brossé	28 002 978-93 0010
	Dark Platinum brossé	28 002 978-99
	Dark Platinum brossé	28 002 978-99 0010

28 002 978

mm [inches]



Diagramme de débit



Codes & Standards

DIN 4109

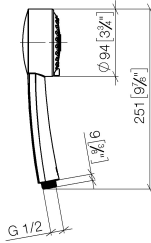
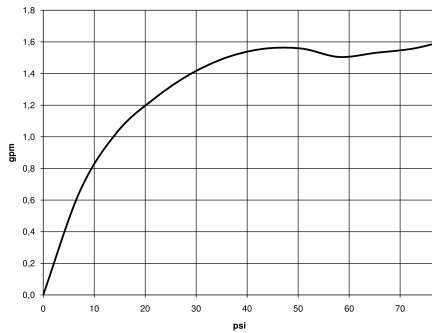
ISO 3822

Ü-Zeichen



MADISON Douchette à main FlowReduce - Laiton brossé (Or 23cts)

MADISON

28 002 978

Certificats

LGA_18

28 002 978

Les pièces pour les
autres finitions
peuvent être
trouvées ici : Chrome

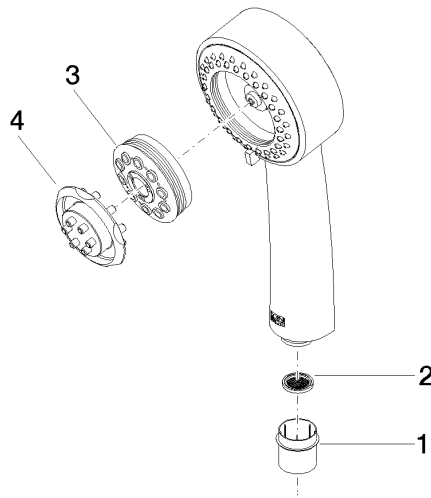



MADISON Douchette à main FlowReduce - Laiton brossé (Or 23cts)

MADISON

28 002 978

Liste des pièces de rechange

N°	Article Numéro	Désignation	Fréquence de montage	Délai de livraison
	09 21 02 115 90	capuchon	4	2