













28 508 360



- saillie 200 mm
- rotule 30° pivotante
- 3 jets réglables : PURIFY RAIN, COMPACT SOFT FLOW, COMPACT AQUAPRESSURE FLOW, débit max. 7,6 l/min (à 3 bar)
- avec système anti-calcaire
- pomme de douche Ø 94 mm
- rosace Ø 55 mm
- raccord 1/2"
- Ce produit contribue au respect des exigences des systèmes d'évaluation des bâtiments écologiques, par exemple LEED®, BREEAM®, DGNB

	Dark Platinum brossé	28 508 360-99 0010
	Chrome	28 508 360-00 0010
	Chrome	28 508 360-00
	Platine brossé	28 508 360-06 0010
	Platine brossé	28 508 360-06
	Platine	28 508 360-08 0010
	Platine	28 508 360-08
	Laiton (Or 23cts)	28 508 360-09 0010
	Laiton (Or 23cts)	28 508 360-09
	Laiton brossé (Or 23cts)	28 508 360-28 0010
	Laiton brossé (Or 23cts)	28 508 360-28
	Dark Platinum brossé	28 508 360-99

28 508 360

mm [inches]



Diagramme de débit



Codes & Standards

DIN 4109

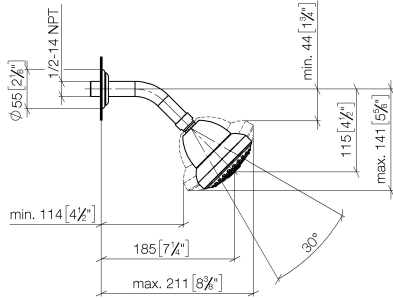
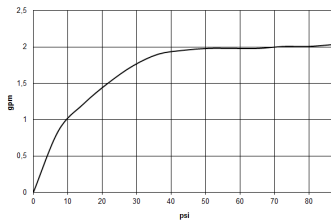
ISO 3822

Ü-Zeichen



MADISON Douche de tête FlowReduce - Dark Platinum brossé

MADISON

28 508 360

Certificats

LGA_38

28 508 360

Les pièces pour les
autres finitions
peuvent être
trouvées ici : Chrome

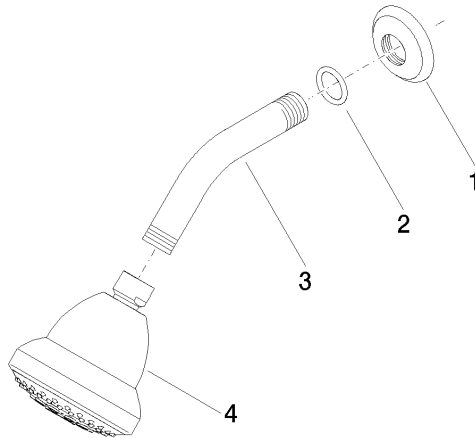



28 508 360

Liste des pièces de rechange

N°	Article Numéro	Désignation	Fréquence de montage	Délai de livraison
	09 27 35 003-99	rosace	4	30