













**META Mitigeur monocommande de lavabo sans garniture d'écoulement -
Chrome**

META

33 526 660 Version du produit jusqu'à 23/01/2020



- saillie 125 mm
- bec déverseur fixe
- jet circulaire enrichi en air
- hauteur de robinetterie 133 mm
- hauteur jusqu'au mousseur 52 mm
- diamètre de percement 35 mm
- 2x flexible de pression M 8 x 1 vissé, étanchéité contrôlée
- débit maxi. 5,7 l/min
- sans plomb
- Ce produit contribue au respect des exigences des systèmes d'évaluation des bâtiments écologiques, par exemple LEED®, BREEAM®, DGNB

	Chrome	33 526 660-00
	Platine brossé	33 526 660-06
	Dark Chrome	33 526 660-19
	Light Gold	33 526 660-26
	Light Gold brossé	33 526 660-27
	Noir mat	33 526 660-33
	Dark Brass brossé	33 526 660-39
	Bronze brossé	33 526 660-42
	Champagne brossé (Or 22cts)	33 526 660-46
	Champagne (Or 22cts)	33 526 660-47
	Chrome brossé	33 526 660-93
	Dark Platinum brossé	33 526 660-99

33 526 660 Version du produit jusqu'à 23/01/2020



Diagramme de débit



Codes & Standards

DIN 4109

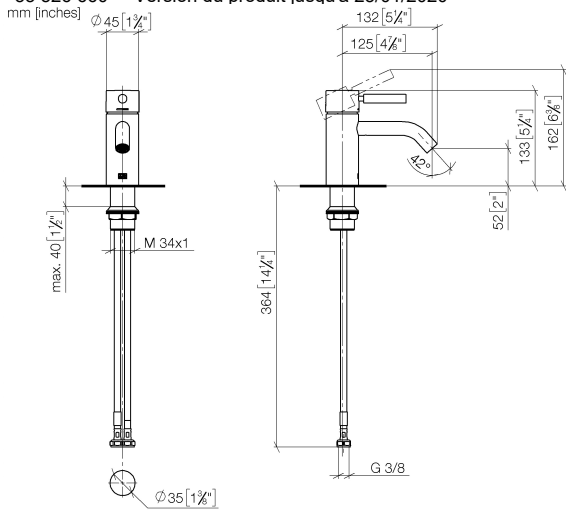
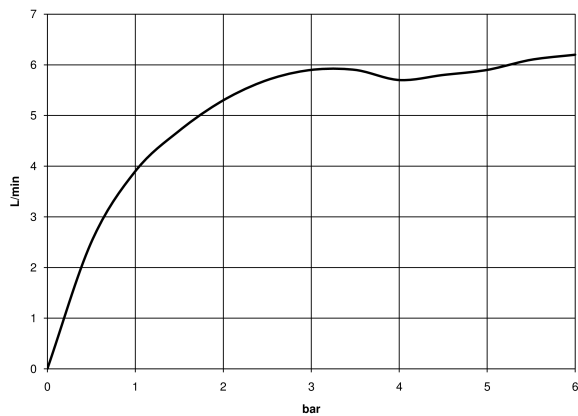
ISO 3822

Scottish Water
Byelaws

UK Water Supply
Regulations

Ü-Zeichen



META Mitigeur monocommande de lavabo sans garniture d'écoulement -
Chrome

META

33 526 660 Version du produit jusqu'à 23/01/2020

Certificats et durabilité

LGA_29

WRAS_2003

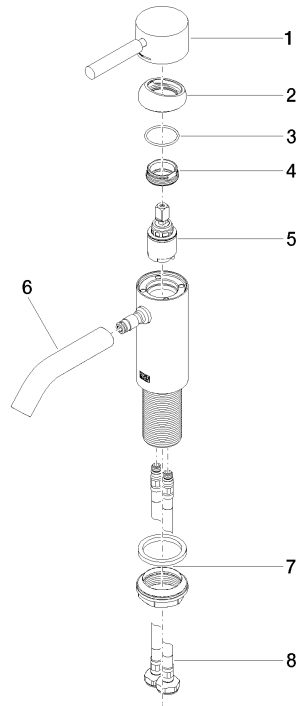

Liste des pièces de rechange

N°	Article Numéro	Désignation	Fréquence de montage	Délai de livraison
5	90 15 05 044 00 90	cartouche	1,00	2
2	09 28 30 041-00	hotte	1,00	10
6	90 11 06 206 00-00	bec déverseur	1,00	10
4	09 24 04 266 90	écrou	1,00	2
7	04 23 10 044 07 90	set de fixation	1,00	2
8	04 30 04 100 00 90	flexible	2,00	2
1	90 20 66 002 00-00	poignée	1,00	10
3	09 14 10 091 90	joint	1,00	2