











33 800 861



- saillie 200 mm
- bec pivotant 360°
- en option, possibilité de limiter le pivotement avec un set de limitation de pivotement 12 820 970 90
- jet enrichi en air
- débit d'eau maxi. 8 l/min avec une pression d'écoulement de 3 bars
- sans plomb
- Ce produit contribue au respect des exigences des systèmes d'évaluation des bâtiments écologiques, par exemple LEED®, BREEAM®, DGNB

	Champagne brossé (Or 22cts)	33 800 861-46
	Chrome	33 800 861-00
	Platine brossé	33 800 861-06
	Platine	33 800 861-08
	Laiton (Or 23cts)	33 800 861-09
	Dark Chrome	33 800 861-19
	Laiton brossé (Or 23cts)	33 800 861-28
	Noir mat	33 800 861-33
	Champagne (Or 22cts)	33 800 861-47
	Chrome brossé	33 800 861-93
	Dark Platinum brossé	33 800 861-99

Accessoires recommandés

Kit de limitation de pivotement - 12 820 970 90



Accessoires recommandés

Distributeur sans rosace - Champagne brossé (Or 22cts) 82 424 970-46



Accessoires recommandés

Commande de vidage individuelle manuelle Commande manuelle - Champagne brossé (Or 22cts) 10 712 970-46



33 800 861



Diagramme de débit



Certificats

LGA_38642.

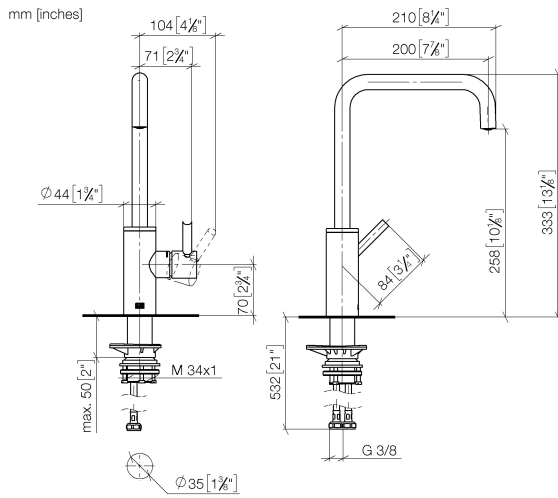
WRAS_240102021.

33 800 861

