









**VAIA Mitigeur monocommande encastré sur plaque de recouvrement - Bronze
brossé**

VAIA

36 060 809



- plaque de recouvrement 80 x 80 mm

	Bronze brossé	36 060 809-42
	Chrome	36 060 809-00
	Platine brossé	36 060 809-06
	Platine	36 060 809-08
	Dark Chrome	36 060 809-19
	Laiton brossé (Or 23cts)	36 060 809-28
	Champagne brossé (Or 22cts)	36 060 809-46
	Champagne (Or 22cts)	36 060 809-47
	Dark Platinum brossé	36 060 809-99

Accessoires requis



Mitigeur monocommande mural à encastrer - 35 860 970 90

- profondeur de montage mini. 80 mm
- profondeur de montage max. 95 mm



VAIA Mitigeur monocommande encastré sur plaque de recouvrement - Bronze
brossé

VAIA

36 060 809

Certificats

LGA_29905.

36 060 809

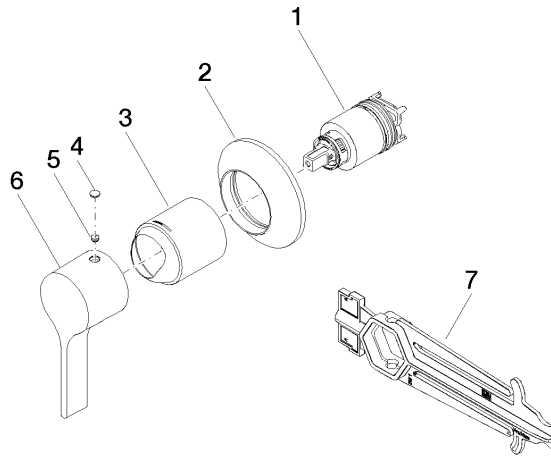

Liste des pièces de rechange

N°	Article Numéro	Désignation	Fréquence de montage	Délai de livraison
1	90 15 05 064 01 90	cartouche	1	2
2	90 27 80 032 00-42	rosace	1	30
3	09 11 02 293-42	hotte	1	60
4	90 31 20 087 00-42	bonde de fond	1	30
5	90 31 11 063 00 90	tige	1	2
6	09 20 80 021-42	poignée	1	60
7	90 30 09 064 00 90	clé à écrou	1	2