







36 060 845



- plaque de recouvrement 78 x 78 mm

	Noir mat	36 060 845-33
	Chrome	36 060 845-00
	Platine brossé	36 060 845-06
	Dark Chrome	36 060 845-19
	Chrome brossé	36 060 845-93
	Dark Platinum brossé	36 060 845-99



LISSÉ Mitigeur monocommande encastré sur plaque de recouvrement - Noir
mat

LISSÉ

36 060 845

Certificats

LGA_29905.

36 060 845
Les pièces pour les
autres finitions
peuvent être
trouvées ici : Chrome

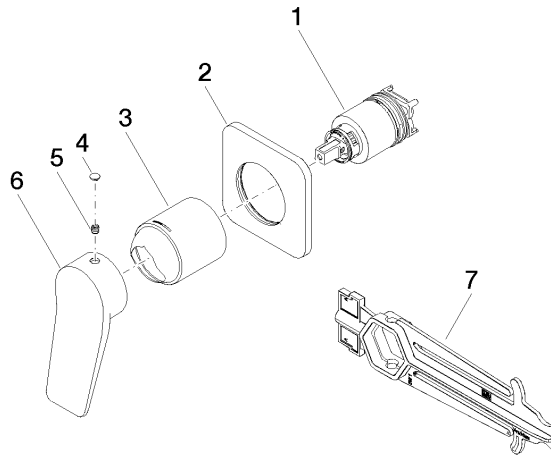

Liste des pièces de rechange

N°	Article Numéro	Désignation	Fréquence de montage	Délai de livraison
1	90 15 05 046 02 90	cartouche	1	2
2	90 27 84 020 00-33	rosace	1	30
3	09 11 02 288-33	hotte	1	30
4	90 31 20 087 00-33	bonde de fond	1	30
5	90 31 11 030 00 90	tige	1	2
6	09 20 84 021-33	poignée	1	30
7	90 30 09 064 00 90	clé à écrou	1	2