







36 200 705

- inverseur rotatif
- rosace 60 x 60 mm



	Platine brossé	36 200 705-06
	Chrome	36 200 705-00
	Dark Chrome	36 200 705-19
	Champagne brossé (Or 22cts)	36 200 705-46
	Champagne (Or 22cts)	36 200 705-47
	Dark Platinum brossé	36 200 705-99

Accessoires requis



- Inverseur à 2 voies à encastrer - 35 202 970 90**
- profondeur de montage max. 160 mm
 - profondeur de montage mini. 115 mm

36 200 705

mm [inches]



Diagramme de débit



Certificats

LGA_38379.

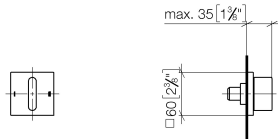
WRAS_2307045.

36 200 705

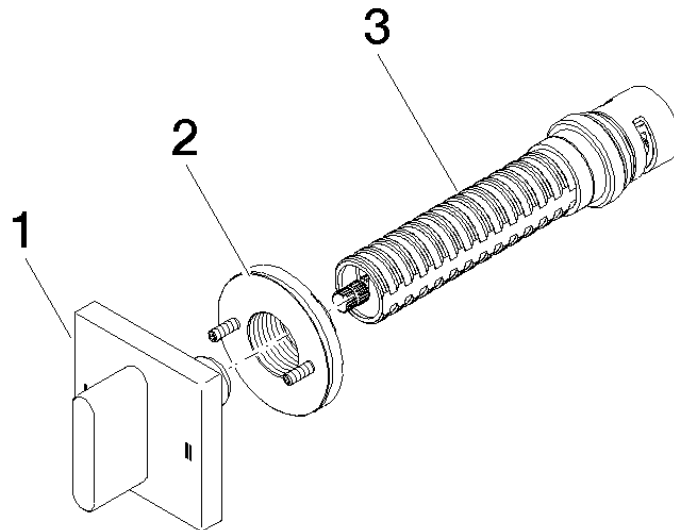

Liste des pièces de rechange

N°	Article Numéro	Désignation	Fréquence de montage	Délai de livraison
1	90 20 70 051 08-06	poignée	1	10
2	90 21 02 181 00 90	rondelle	1	2
3	90 90 03 304 10 90	inverseur	1	2