







36 200 980

- inverseur rotatif
- rosace 60 x 60 mm



	Dark Platinum brossé	36 200 980-99
	Chrome	36 200 980-00
	Platine brossé	36 200 980-06
	Or clair brossé	36 200 980-27
	Laiton brossé (Or 23cts)	36 200 980-28
	Champagne brossé (Or 22cts)	36 200 980-46
	Champagne (Or 22cts)	36 200 980-47

### Accessoires requis



- Inverseur à 2 voies à encastrer -** 35 202 970 90
- profondeur de montage max. 160 mm
  - profondeur de montage mini. 85 mm

36 200 980

mm [inches]

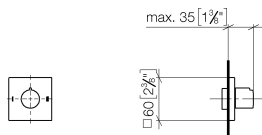

**Diagramme de débit**

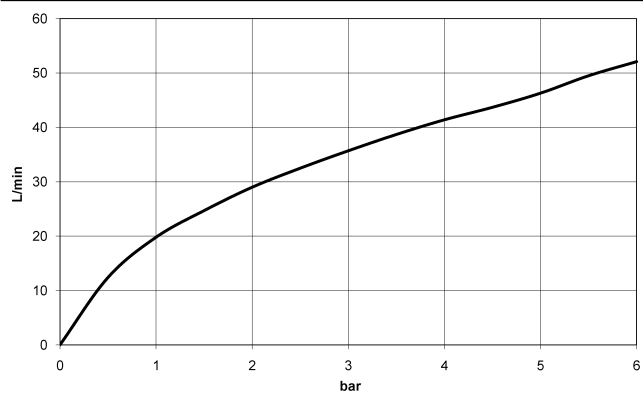

**Certificats**

LGA\_38379.

WRAS\_2307045.

36 200 980

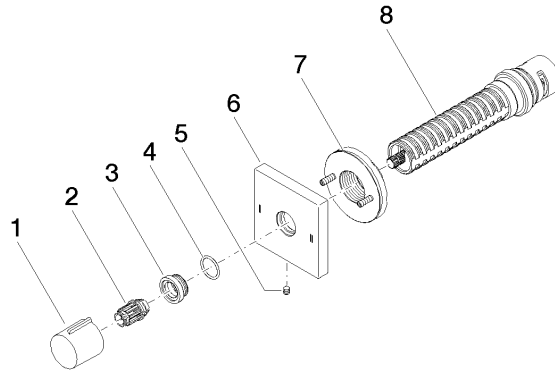

### Liste des pièces de rechange

N°	Article Numéro	Désignation	Fréquence de montage	Délai de livraison
1	09 20 98 001-99	poignée	1	30
2	09 12 12 005 90	douille d'enclenchement	1	2
3	09 12 12 043-99	prise	1	30
4	09 14 10 017 90	joint	1	2
5	09 31 11 294 90	tige	1	2
6	09 27 98 037-99	rosace	1	30
7	90 21 02 181 00 90	rondelle	1	2
8	90 90 03 304 10 90	inverseur	1	2