

36 501 985



- plaque de recouvrement 120 x 120 mm
- poignée de graduation avec bouton de sécurité à 38°C
- cartouche de thermostat

S'adapte aux gammes suivantes : IMO, MEM, CL.1, CYO

	Platine brossé	36 501 985-06
	Chrome	36 501 985-00
	Platine	36 501 985-08
	Dark Chrome	36 501 985-19
	Or clair brossé	36 501 985-27
	Laiton brossé (Or 23cts)	36 501 985-28
	Noir mat	36 501 985-33
	Champagne brossé (Or 22cts)	36 501 985-46
	Champagne (Or 22cts)	36 501 985-47
	Chrome brossé	36 501 985-93
	Dark Platinum brossé	36 501 985-99

Accessoires requis



xTOOL Module de thermostat à encastrer sans réglage du débit - 35 503 970 90

- profondeur de montage max. 160 mm
- profondeur de montage mini. 95 mm

Accessoires requis



xGRID Rail de montage 555 mm - 12 360 970 90

Accessoires recommandés



xGRID Jeu de fixation pour l'intégration dans la construction sèche - 12 340 970 90

36 501 985

mm [inches]



Certificats

WRAS_2011026.

DVGW_DW-
6512DN0706.

LGA_29930.

LGA_29932.

36 501 985

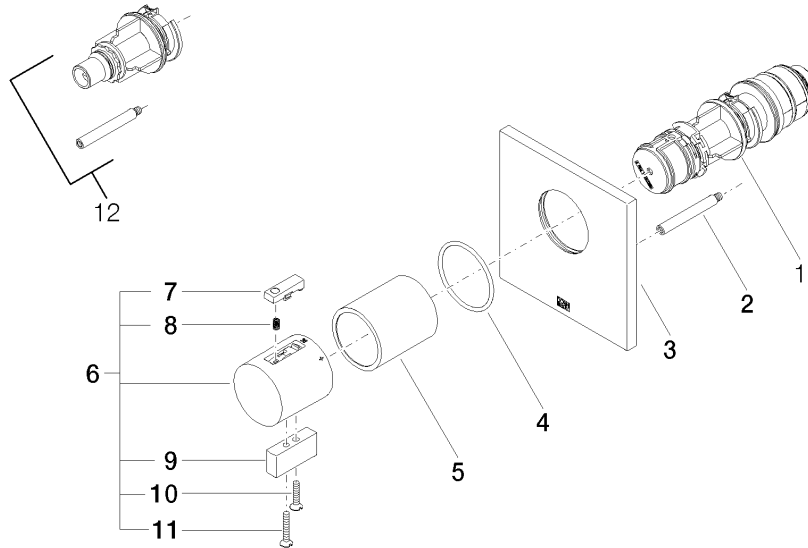

Liste des pièces de rechange

N°	Article Numéro	Désignation	Fréquence de montage	Délai de livraison
1	90 15 02 063 00 90	cartouche	1	2
2	90 31 09 095 00 90	barre	1	2
3	09 11 02 196-06	recouvrement	1	60
4	90 14 10 049 00 90	joint	1	2
5	90 21 02 112 00-06	douille	1	10
6	04 17 33 006 00-06	poignée	1	60
7	90 21 33 011 00-13	poignée	1	2
8	90 16 02 027 00 90	ressort	1	2
9	09 20 33 006-06	poignée	1	10
10	09 30 30 159-06	vis	1	10
11	09 30 30 160-06	vis	1	10
12	12 178 970 90	Rallonge 46 mm -	1	2