









36 607 819



- rosace Ø 60 mm
- tête de commande avec broche et douille à sectionner

	Champagne (Or 22cts)	36 607 819-47
	Chrome	36 607 819-00
	Platine brossé	36 607 819-06
	Platine	36 607 819-08
	Dark Chrome	36 607 819-19
	Laiton brossé (Or 23cts)	36 607 819-28
	Bronze brossé	36 607 819-42
	Champagne brossé (Or 22cts)	36 607 819-46
	Dark Platinum brossé	36 607 819-99

Accessoires requis



- Robinet à encastrer 1/2" - 35 607 970 90**
- profondeur de montage max. 145 mm
 - profondeur de montage mini. 75 mm

36 607 819

mm [inches]

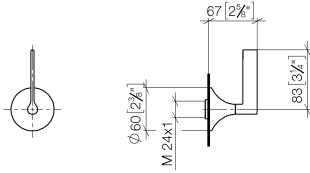

Certificats

DVGW_DW-
6501DN0116.

WRAS_2011026.

LGA_29931.

WRAS_2010066.

DVGW_DW-
6512DN0706.

36 607 819

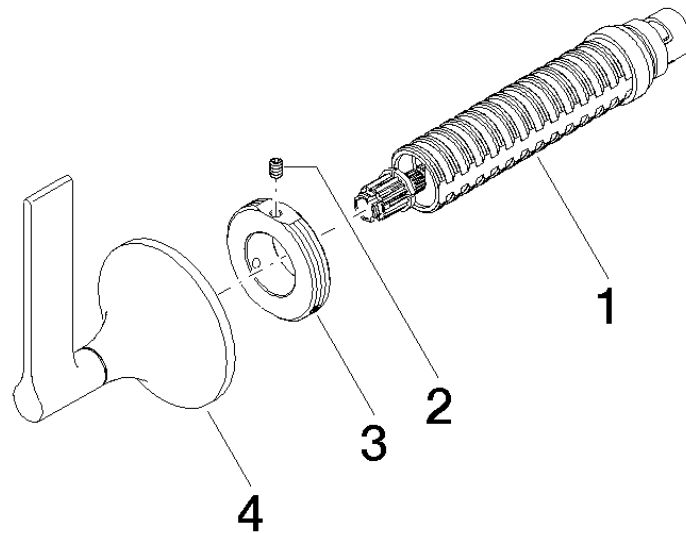

Liste des pièces de rechange

N°	Article Numéro	Désignation	Fréquence de montage	Délai de livraison
1	90 90 03 143 00 90	tête céramique	1	2
2	09 31 11 008 90	tige	1	2
3	09 21 02 163 90	rondelle	1	2
4	90 20 80 015 00-47	poignée	1	30