







ST 010 108 7811



- saillie 167 mm
- bec déverseur fixe
- jet rectangulaire enrichi en air
- hauteur de robinetterie 198 mm
- hauteur jusqu'au mousseur 133 mm
- diamètre de percement du bec 35 mm
- diamètre de percement des robinets latéraux 32 mm
- poignée Ø 60 mm
- 2x flexible de pression M 8 x 1 vissé, étanchéité contrôlée
- 1x flexible de pression M 10 x 1 vissé, étanchéité contrôlée
- débit maxi. 4,5 l/min
- cartouche innovante
- sans plomb
- avec marquage chaud/froid
- Ce produit contribue au respect des exigences des systèmes d'évaluation des bâtiments écologiques, par exemple LEED®, BREEM®, DGNB

	Chrome	ST 010 108 7811-00
	Platine brossé	ST 010 108 7811-06
	Dark Chrome	ST 010 108 7811-19
	Laiton brossé (Or 23cts)	ST 010 108 7811-28
	platine / platine mat	ST 010 108 7811-36
	Laiton / Laiton brossé (Or 23cts)	ST 010 108 7811-38
	Dark Platinum brossé	ST 010 108 7811-99

Composants individuels de ce set

Ce set requiert les composants suivants

1x 29 218 811-00



1x 11 188 811-00









ST 010 108 7811



- saillie 167 mm
- bec déverseur fixe
- jet rectangulaire enrichi en air
- hauteur de robinetterie 198 mm
- hauteur jusqu'au mousseur 133 mm
- diamètre de percement du bec 35 mm
- diamètre de percement des robinets latéraux 32 mm
- poignée Ø 60 mm
- 2x flexible de pression M 8 x 1 vissé, étanchéité contrôlée
- 1x flexible de pression M 10 x 1 vissé, étanchéité contrôlée
- débit maxi. 4,5 l/min
- cartouche innovante
- sans plomb
- Ce produit contribue au respect des exigences des systèmes d'évaluation des bâtiments écologiques, par exemple LEED®, BREEAM®, DGNB

ATTENTION : les inserts à poignée doivent être commandés séparément des robinetteries !

	Chrome	29 218 811-00
	Platine brossé	29 218 811-06
	Dark Chrome	29 218 811-19
	Laiton brossé (Or 23cts)	29 218 811-28
	platine / platine mat	29 218 811-36
	Laiton / Laiton brossé (Or 23cts)	29 218 811-38
	Dark Platinum brossé	29 218 811-99

ST 010 108 7811



Diagramme de débit



Certificats

WRAS_2201012. LGA_38103.

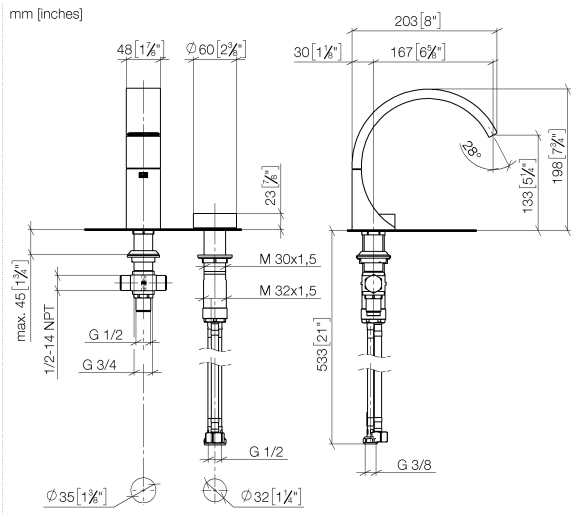
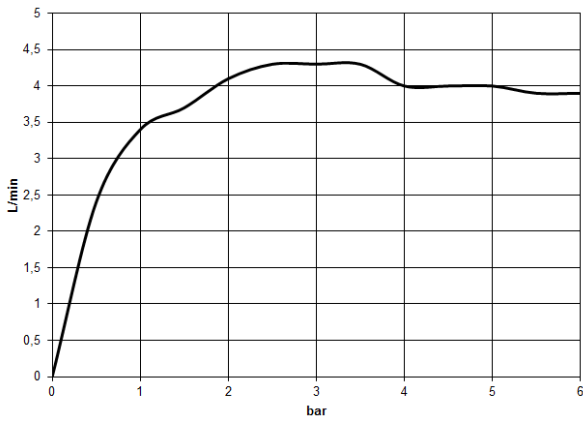
ST 010 108 7811

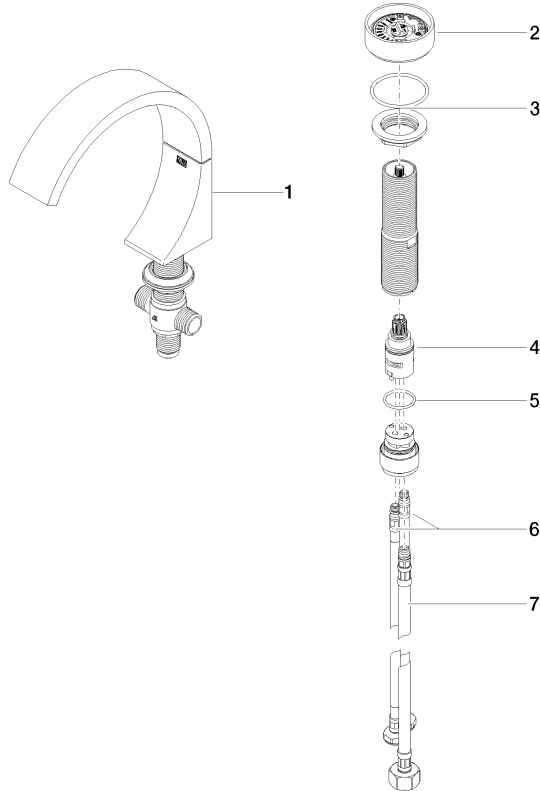







Liste des pièces de rechange

N°	Article Numéro	Désignation	Fréquence de montage	Délai de livraison
1	13 717 811-00	CYO Bec déverseur pour lavabo, montage sur gorge sans garniture d'écoulement - Chrome	1	10
2	90 18 40 290 00-00	poignée	1	10
3	04 30 11 038 67 90	set de fixation	1	2
4	90 90 03 169 00 90	tête céramique	1	2
5	09 14 10 112 90	joint	1	2
6	04 30 04 100 00 90	flexible	2	2
7	04 30 04 019 00 90	flexible	1	2

ST 010 108 7811



- avec marquage chaud/froid
- pour mélangeur de lavabo à deux trous

	Chrome	11 188 811-00
	Platine brossé	11 188 811-06
	Platine	11 188 811-08
	Laiton (Or 23cts)	11 188 811-09
	Dark Chrome	11 188 811-19
	Laiton brossé (Or 23cts)	11 188 811-28
	Dark Platinum brossé	11 188 811-99

ST 010 108 7811

mm [inches]

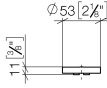

ST 010 108 7811

Les pièces pour les
autres finitions
peuvent être
trouvées ici : Platine
brossé

