







ST 110 107 9875



- saillie 241 mm
- bec pivotant 360°
- jet enrichi en air et jet douchette
- hauteur de robinetterie 393 mm
- hauteur de la douchette pendulaire environ 665 mm
- hauteur jusqu'au mousseur 240 mm
- diamètre de percement mitigeur monocommande 35 mm
- diamètre de percement douchette pendulaire 30 mm
- inverseur automatique sortie/douchette
- tête de douchette avec système anticalcaire
- débit d'eau maxi. 8 l/min avec une pression d'écoulement de 3 bars
- sans plomb
- Ce produit contribue au respect des exigences des systèmes d'évaluation des bâtiments écologiques, par exemple LEED®, BREEAM®, DGNB

	Chrome brossé	ST 110 107 9875-93
	Chrome	ST 110 107 9875-00
	Platine brossé	ST 110 107 9875-06
	Platine	ST 110 107 9875-08
	Dark Chrome	ST 110 107 9875-19
	Dark Platinum brossé	ST 110 107 9875-99

Composants individuels de ce set

Ce set requiert les composants suivants



1x 27 789 970-93



1x 33 826 875-93



TARA ULTRA Mitigeur monocommande avec douchette pendulaire - Chrome
brossé

TARA ULTRA

ST 110 107 9875

ST 110 107 9875









S'adapte aux gammes suivantes : ELIO,
TARA, TARA ULTRA

- jet douchette
- inverseur automatique bec/douchette pendulaire
- hauteur de robinetterie 665 mm
- rosace individuelle Ø 55 mm
- diamètre de percement douchette pendulaire 30 mm
- tête de douchette avec système anticalcaire
- sans plomb

Uniquement combinable avec 33826790, 32800790,
33826888, 32815888, 20815892, 33826875.

Avec sécurité anti-retour.

	Chrome brossé	27 789 970-93
	Chrome	27 789 970-00
	Platine brossé	27 789 970-06
	Platine	27 789 970-08
	Dark Chrome	27 789 970-19
	Dark Platinum brossé	27 789 970-99

ST 110 107 QR75
mm [inches]
M 1:10



Diagramme de débit



Codes & Standards

EnergieEtikette B

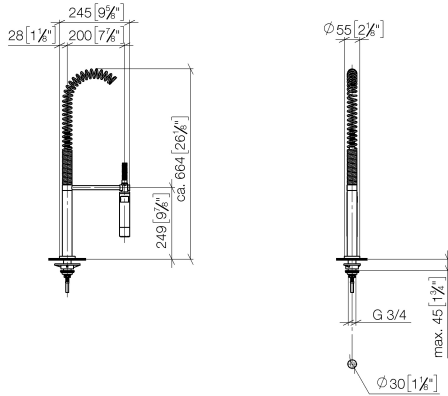
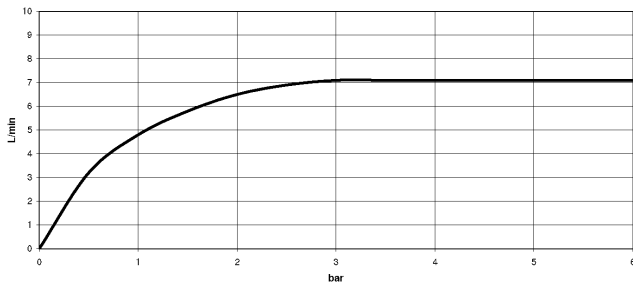
Certificats

LGA_18901. Belgaqua_22_277_2
7_3.



TARA ULTRA Mitigeur monocommande avec douchette pendulaire - Chrome
brossé

TARA ULTRA

ST 110 107 9875

ST 110 107 9875

Les pièces pour les
autres finitions
peuvent être
trouvées ici : Chrome

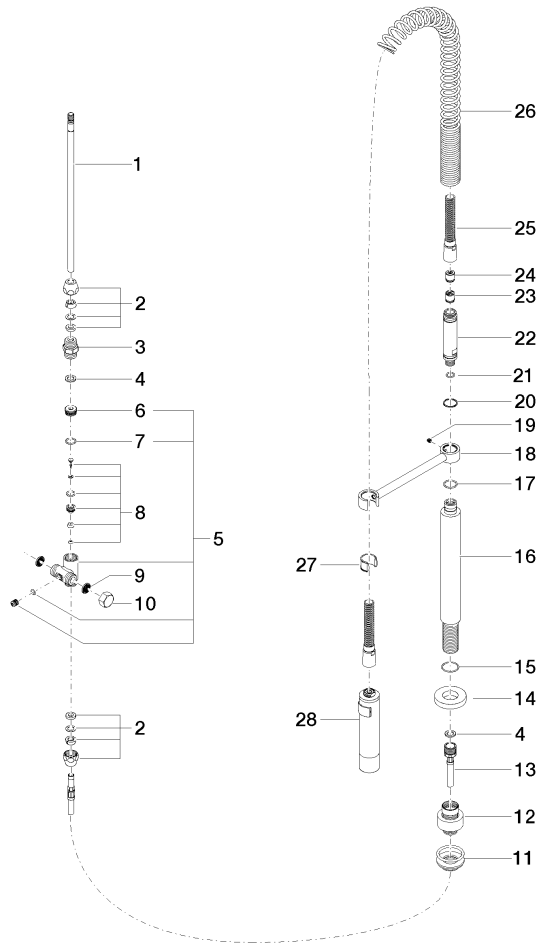

ST 110 107 9875

Liste des pièces de rechange

N°	Article Numéro	Désignation	Fréquence de montage	Délai de livraison
1	04 24 02 046 01-07	tuyau	1	10
2	90 23 30 040 00-93	joint américain	2	20
3	90 24 03 168 00 90	raccord à vis	1	2
4	90 14 20 002 00 90	joint	2	2
5	90 17 09 046 10 90	inverseur	1	2
6	09 24 04 112 10 90	raccord à vis	1	2
7	90 14 10 033 00 90	joint	1	2
8	90 21 10 031 10 90	inverseur	1	2
9	09 23 01 039 90	tamis	2	2
10	04 21 02 006 00 92	capuchon	1	2
11	04 23 10 004 03 90	set de fixation	1	2
12	12 780 970 90	Set de rallonges -	1	60
13	09 30 04 067 90	flexible	1	2
14	09 28 10 064-93	rosace	1	60
15	09 14 10 120 90	joint	1	2
16	09 11 10 066 10-93	raccord	1	20
17	09 14 10 031 90	joint	1	2
18	04 17 20 014 00-93	patte de fixation	1	60
19	09 31 11 049 90	tige	1	2
20	09 14 15 012 90	anneau	1	2
21	09 14 10 003 90	joint	1	2
22	09 30 01 067 10-93	adaptateur	1	60
23	90 23 01 141 00 90	anti-retour	1	2
24	09 23 01 046 90	anti-retour	1	2
25	90 30 02 065 00-93	flexible	1	20
26	09 16 02 034 90	ressort	1	2
27	90 18 40 035 00 90	douille	1	2
28	04 12 11 094 10-93	douche	1	20



TARA ULTRA Mitigeur monocommande avec douchette pendulaire - Chrome
brossé

TARA ULTRA

ST 110 107 9875

ST 110 107 9875



- saillie 241 mm
- bec pivotant 360°
- jet enrichi en air
- hauteur de robinetterie 393 mm
- hauteur jusqu'au mousseur 240 mm
- diamètre de percement mitigeur monocommande 35 mm
- débit d'eau maxi. 8 l/min avec une pression d'écoulement de 3 bars
- sans plomb
- Ce produit contribue au respect des exigences des systèmes d'évaluation des bâtiments écologiques, par exemple LEED®, BREEAM®, DGNB

Mitigeur monocommande à combiner uniquement avec une douchette extractible/pendulaire

	Chrome brossé	33 826 875-93
	Chrome	33 826 875-00
	Platine brossé	33 826 875-06
	Platine	33 826 875-08
	Laiton (Or 23cts)	33 826 875-09
	Dark Chrome	33 826 875-19
	Laiton brossé (Or 23cts)	33 826 875-28
	Noir mat	33 826 875-33
	Champagne brossé (Or 22cts)	33 826 875-46
	Champagne (Or 22cts)	33 826 875-47
	Dark Platinum brossé	33 826 875-99

Accessoires requis



Douchette pendulaire - Chrome brossé 27 789 970-93

Accessoires requis



Douchette extractible - Chrome brossé 27 721 970-93



TARA ULTRA Mitigeur monocommande avec douchette pendulaire - Chrome
brossé

TARA ULTRA

ST 110 107 9875

ST 110 107 QR75



Diagramme de débit



Codes & Standards

EnergieEtikette A

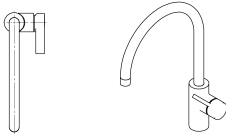
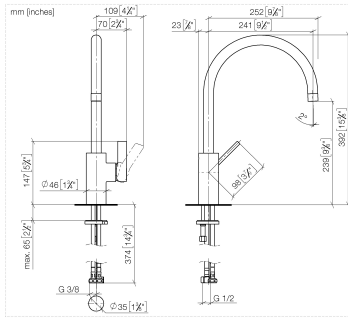
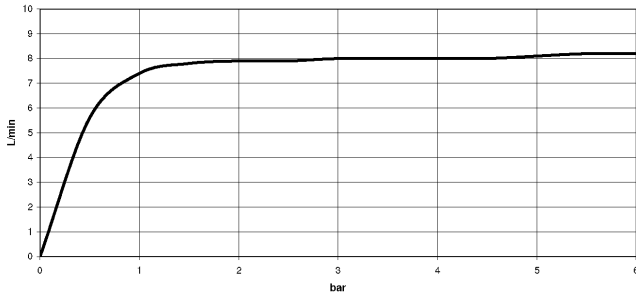
Certificats

LGA_18901.



TARA ULTRA Mitigeur monocommande avec douchette pendulaire - Chrome
brossé

TARA ULTRA

ST 110 107 9875

