

Piastra di lavaggio per cassette WC-UP di Geberit rotondo - Light Gold spazzolato





IMO

12 665 979



- piastra di copertura 169 x 246 x 12 mm
- Piastra di azionamento meccanica con attivazione sciacquone manuale
- Per tecnologia di lavaggio in 2 quantità
- Incl. telai di fissaggio, asta di azionamento e materiali di fissaggio
- Aste di spinta silenziate, regolazione rapida senza attrezzi
- Compatibile con tutte le cassette della serie Geberit Sigma dal 2001

Compatibile con: IMO, LULU, MADISON, TARA, LISSÉ, VAIA, META, CYO

	Light Gold spazzolato	12 665 979-27
	Cromato	12 665 979-00
	Platinato spazzolato	12 665 979-06
	Platinato	12 665 979-08
	Ottone (Oro 23k)	12 665 979-09
	Dark Chrome	12 665 979-19
	Light Gold	12 665 979-26
	Ottone spazzolato (Oro 23k)	12 665 979-28
	Nero opaco	12 665 979-33
	Bronzo spazzolato	12 665 979-42
	Champagne spazzolato (Oro 22k)	12 665 979-46
	Champagne (Oro 22k)	12 665 979-47
	Cromo spazzolato	12 665 979-93
	Dark Platinum spazzolato	12 665 979-99

Piastra di lavaggio per cassette WC-UP di Geberit rotondo - Light Gold
spazzolato

IMO

12 665 979

mm [inches]

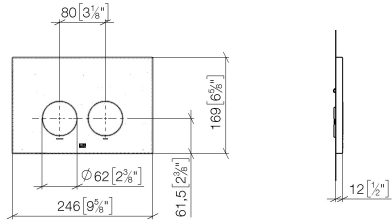

12 665 979
Parts for other
finishes can be found
here: Cromato

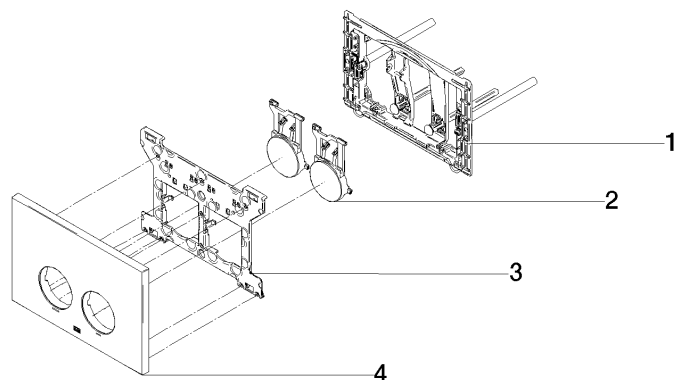

Elenco delle parti di ricambio

N.	Codice articolo	Denominazione	Quantità necessaria	Tempo di produzione
1	90 28 01 030 00 90	alloggio	1	2
2	90 20 97 100 00-27	pulsante	2	30
3	90 28 10 212 00 90	alloggio	1	2
4	90 11 97 012 00-27	copertura	1	30