







28 450 845



- uscita doccetta 3/8"
- rosetta 60 x 78 mm
- ingresso 1/2"

Sistema di sicurezza antiriflusso.

	Light Gold spazzolato	28 450 845-27
	Cromato	28 450 845-00
	Platinato spazzolato	28 450 845-06
	Dark Chrome	28 450 845-19
	Nero opaco	28 450 845-33
	Cromo spazzolato	28 450 845-93
	Dark Platinum spazzolato	28 450 845-99

Prodotti complementari

**raccordo angolare ad incasso -** 35 085 970 90

- profondità d'incasso min. 90 mm
- Profondità d'incasso max. 163 mm



28 450 845

mm [inches]

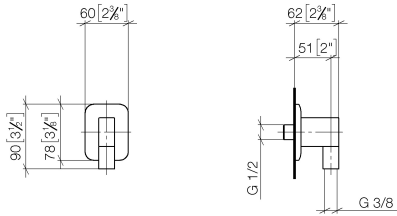

**Diagramma di portata**



**Certificati**

WRAS\_2310091.

28 450 845

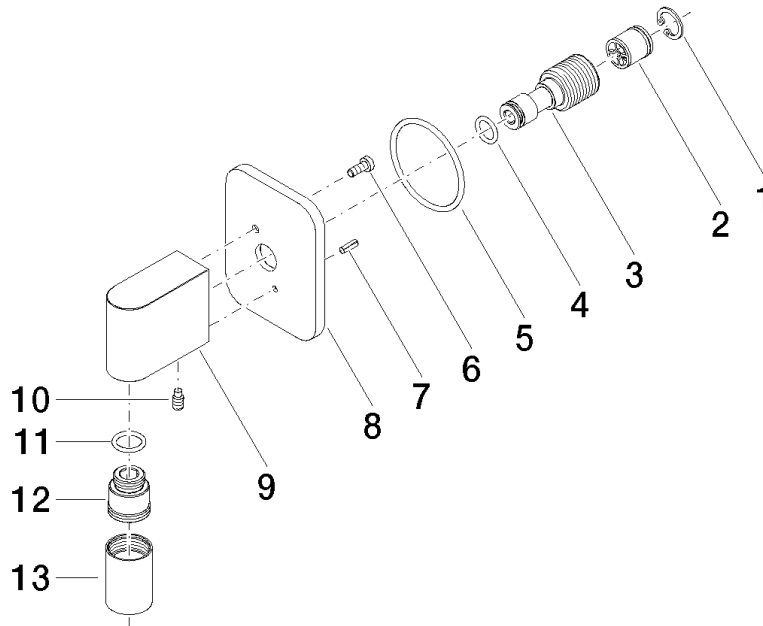

### Elenco delle parti di ricambio

N.	Codice articolo	Denominazione	Quantità necessaria	Tempo di produzione
1	09 16 01 014 90	anello	1	2
2	90 23 01 141 00 90	valvola di non ritorno	1	2
3	09 24 03 116 20 90	ugello	1	2
4	09 14 10 008 90	guarnizione	1	2
5	09 14 10 142 90	guarnizione	1	2
6	09 30 30 054 90	vite	1	2
7	09 31 11 026 90	perno	1	2
9	09 11 03 046-27	attacco	1	60
10	09 31 11 005 90	perno	1	2
11	90 14 10 077 00 90	guarnizione	1	2
12	09 24 03 107 20 90	ugello	1	2
13	90 21 02 069 00-27	copertura	1	30