

## Soffione a pioggia con fissaggio a muro 220 mm - Champagne spazzolato (Oro 22k)

28 649 970 Versione del prodotto da 3/13/2017



- sporgenza 450 mm
- Soffione a pioggia Ø 220 mm
- PURE RAIN, portata max 14 l/min (a 3 bar)
- Funzione a partire da: 7 l/min
- rosetta Ø 60 mm
- ingresso 1/2"
- con sistema anticalcare
- con funzione neutra

	Champagne spazzolato (Oro 22k)	28 649 970-46
	Cromato	28 649 970-00
	Platinato spazzolato	28 649 970-06
	Platinato	28 649 970-08
	Dark Chrome	28 649 970-19
	Light Gold	28 649 970-26
	Light Gold spazzolato	28 649 970-27
	Ottone spazzolato (Oro 23k)	28 649 970-28
	Nero opaco	28 649 970-33
	Bronzo spazzolato	28 649 970-42
	Champagne (Oro 22k)	28 649 970-47
	Cromo spazzolato	28 649 970-93
	Dark Platinum spazzolato	28 649 970-99

### Prodotti complementari



- raccordo angolare ad incasso - 35 085 970 90**
- Profondità d'incasso max. mm
  - profondità d'incasso min. mm

**Soffione a pioggia con fissaggio a muro 220 mm - Champagne spazzolato (Oro 22k)**

28 649 970 Versione del prodotto da 3/13/2017  
mm [inches]

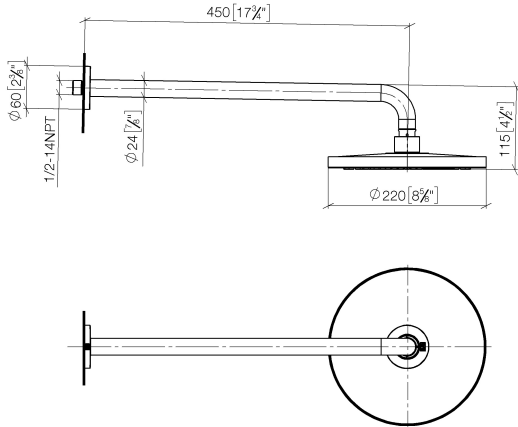

**Diagramma di portata**

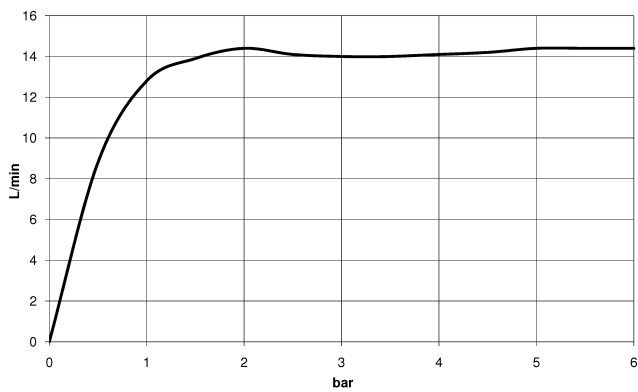

**Codes & Standards**

DIN 4109

EN 1112

ISO 3822

Scottish Water  
Byelaws

UK Water Supply  
Regulations

Ü-Zeichen



## Soffione a pioggia con fissaggio a muro 220 mm - Champagne spazzolato (Oro 22k)

---

28 649 970 Versione del prodotto da 3/13/2017

### Certificati

---

WRAS\_2212

DVGW\_DW-  
6517DN0

LGA\_38

**Soffione a pioggia con fissaggio a muro 220 mm - Champagne spazzolato (Oro 22k)**

28 649 970 Versione del prodotto da 3/13/2017

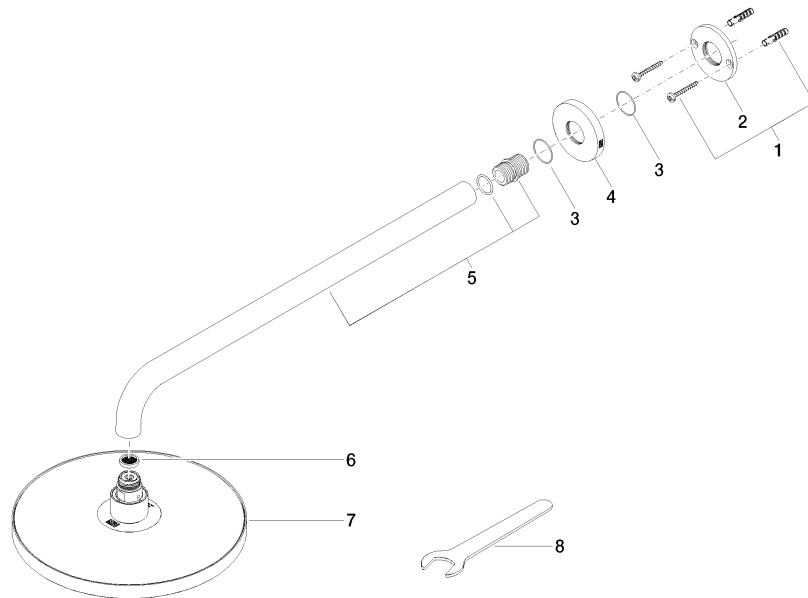

**Elenco delle parti di ricambio**

N.	Codice articolo	Denominazione	Quantità necessaria	Tempo di produzione
1	04 30 31 032 00 90	set di fissaggio	1	2
2	09 17 20 120 90	sostegno	1	2
3	09 14 10 150 90	guarnizione	2	2
4	09 27 97 015-46	rosetta	1	30
5	90 11 03 070 00-46	tubo	1	30
6	09 23 01 075 90	inserto	1	2
7	04 12 05 092 00-46	doccia	1	60
8	90 30 09 069 00 90	chiave	1	2