

36 200 980

- deviatore a rotazione
- rosetta 60 x 60 mm



	Dark Platinum spazzolato	36 200 980-99
	Cromato	36 200 980-00
	Platinato spazzolato	36 200 980-06
	Light Gold spazzolato	36 200 980-27
	Ottone spazzolato (Oro 23k)	36 200 980-28
	Champagne spazzolato (Oro 22k)	36 200 980-46
	Champagne (Oro 22k)	36 200 980-47

Prodotti complementari necessari



- Deviatore a due vie incasso -** 35 202 970 90
- Profondità d'incasso max. 160 mm
 - profondità d'incasso min. 85 mm

36 200 980

mm [inches]



Diagramma di portata



Certificati

LGA_38379.

WRAS_2307045.

36 200 980

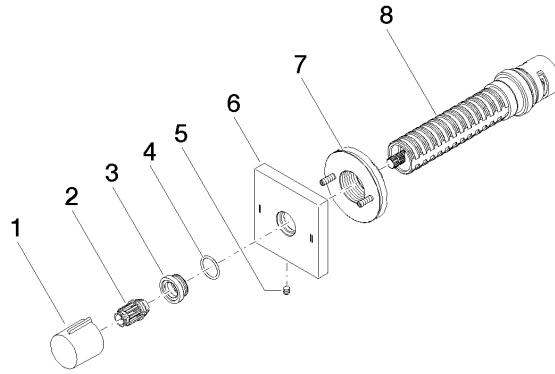

Elenco delle parti di ricambio

N.	Codice articolo	Denominazione	Quantità necessaria	Tempo di produzione
1	09 20 98 001-99	manopola	1	30
2	09 12 12 005 90	bussola a scatto	1	2
3	09 12 12 043-99	alloggio	1	30
4	09 14 10 017 90	guarnizione	1	2
5	09 31 11 294 90	perno	1	2
6	09 27 98 037-99	rosetta	1	30
7	90 21 02 181 00 90	rondella	1	2
8	90 90 03 304 10 90	deviatore	1	2