

36 608 980



- rosetta 60 x 60 mm
- parte superiore con perno e boccola accorciabili

	Platinato	36 608 980-08
	Cromato	36 608 980-00
	Platinato spazzolato	36 608 980-06
	Dark Chrome	36 608 980-19
	Light Gold spazzolato	36 608 980-27
	Ottone spazzolato (Oro 23k)	36 608 980-28
	Nero opaco	36 608 980-33
	Cromo spazzolato	36 608 980-93
	Dark Platinum spazzolato	36 608 980-99

Prodotti complementari necessari



- Rubinetto da incasso 3/4" - 35 608 970 90**
- Profondità d'incasso max. 145 mm
 - profondità d'incasso min. 75 mm

36 608 980

mm [inches]

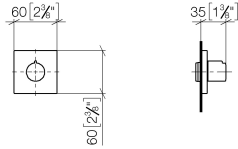

Certificati

IAPMO_4976 (2). WRAS_2010066.

36 608 980

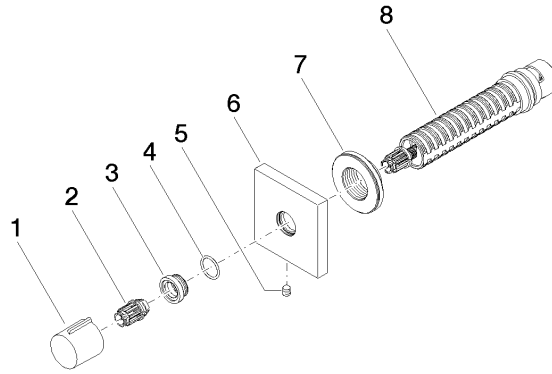

Elenco delle parti di ricambio

N.	Codice articolo	Denominazione	Quantità necessaria	Tempo di produzione
1	09 20 98 001-08	manopola	1	40
2	09 12 12 005 90	bussola a scatto	1	2
3	09 12 12 043-08	alloggio	1	40
4	09 14 10 017 90	guarnizione	1	2
5	90 31 11 004 00 90	perno	1	2
6	09 27 98 014-08	rosetta	1	40
7	09 21 02 151 90	bussola	1	2
8	90 90 03 128 00 90	parte superiore	1	2