

ST 050 302 4892



- sporgenza doccia a stelo 452 mm
- Soffione a pioggia: PURE RAIN, portata max 7 l/min (a 3 bar)
- Funzione a partire da: 6 l/min
- Soffione a pioggia Ø 220 mm
- soffione a pioggia con sistema anticalcare
- Doccetta: COMPACT RAIN, portata max. 15 l/min (a 3 bar)
- Deviatore a rotazione con regolazione di portata e funzione di arresto
- rosette scorrevoli Ø 70 mm
- distanza batteria fino soffione a pioggia (bordo inferiore) 964mm
- distanza batteria fino bordo superiore arco 1267mm
- Interasse 150 mm ± 13 mm
- Flessibile doccetta in metallo 1750mm con protezione antitorsione integrata
- ingresso 1/2"
- asta da parete con supporto scorrevole
- Diametro del tubo 23,5 mm

	Cromato	ST 050 302 4892-00
	Platinato spazzolato	ST 050 302 4892-06
	Platinato	ST 050 302 4892-08
	Dark Chrome	ST 050 302 4892-19
	Ottone spazzolato (Oro 23k)	ST 050 302 4892-28
	Nero opaco	ST 050 302 4892-33
	Champagne spazzolato (Oro 22k)	ST 050 302 4892-46
	Champagne (Oro 22k)	ST 050 302 4892-47
	Cromo spazzolato	ST 050 302 4892-93
	Dark Platinum spazzolato	ST 050 302 4892-99

Componenti singoli di questo set

Per questo set sono necessari i seguenti componenti

1x 28 015 979-00



1x 34 458 892-00



ST 050 302 4892



- COMPACT RAIN, portata max. 15 l/min (a 3 bar)
- con sistema anticalcare
- Soffione Ø 100mm
- ingresso 1/2"

Sistema di sicurezza antiriflusso.

Compatibile con: IMO, LULU, MADISON, MEM, TARA, CL.1, LISSÉ, VAIA, META, CYO

	Cromato	28 015 979-00
	Cromato	28 015 979-00 0010
	Platinato spazzolato	28 015 979-06
	Platinato spazzolato	28 015 979-06 0010
	Platinato	28 015 979-08
	Platinato	28 015 979-08 0010
	Dark Chrome	28 015 979-19
	Dark Chrome	28 015 979-19 0010
	Light Gold	28 015 979-26 0010
	Light Gold	28 015 979-26
	Light Gold spazzolato	28 015 979-27
	Light Gold spazzolato	28 015 979-27 0010
	Ottone spazzolato (Oro 23k)	28 015 979-28
	Ottone spazzolato (Oro 23k)	28 015 979-28 0010
	Nero opaco	28 015 979-33
	Nero opaco	28 015 979-33 0010
	Bronzo spazzolato	28 015 979-42
	Bronzo spazzolato	28 015 979-42 0010
	Champagne spazzolato (Oro 22k)	28 015 979-46 0010
	Champagne spazzolato (Oro 22k)	28 015 979-46
	Champagne (Oro 22k)	28 015 979-47
	Champagne (Oro 22k)	28 015 979-47 0010
	Cromo spazzolato	28 015 979-93
	Cromo spazzolato	28 015 979-93 0010
	Dark Platinum spazzolato	28 015 979-99
	Dark Platinum spazzolato	28 015 979-99 0010

ST 050 302 4892

mm [inches]



Diagramma di portata

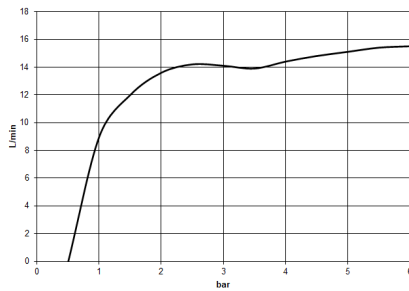

Certificati

DVGW_DW-
6517DN0129.

WRAS_2009011.

LGA_29981.

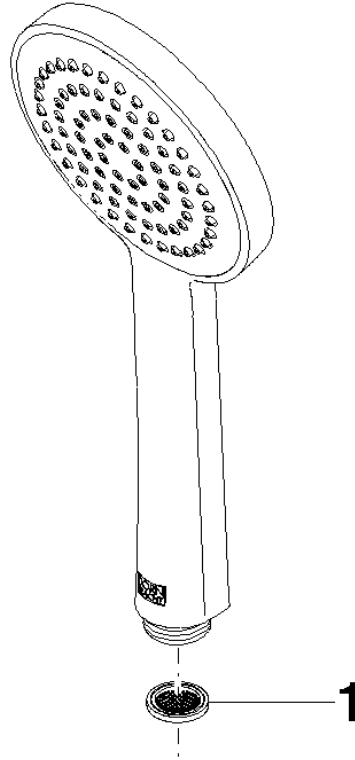

Elenco delle parti di ricambio

N.	Codice articolo	Denominazione	Quantità necessaria	Tempo di produzione
1	09 23 01 039 90	setaccio	1	2

ST 050 302 4892



- sporgenza doccia a stelo 452 mm
- Soffione a pioggia: PURE RAIN, portata max 7 l/min (a 3 bar)
- Funzione a partire da: 6 l/min
- Soffione a pioggia Ø 220 mm
- soffione a pioggia con sistema anticalcare
- Deviatore a rotazione con regolazione di portata e funzione di arresto
- rosette scorrevoli Ø 70 mm
- distanza batteria fino soffione a pioggia (bordo inferiore) 964mm
- distanza batteria fino bordo superiore arco 1267mm
- Interasse 150 mm ± 13 mm
- Flessibile doccia in metallo 1750mm con protezione antitorsione integrata
- ingresso 1/2"
- asta da parete con supporto scorrevole
- Diametro del tubo 23,5 mm
- Questo prodotto può aiutare un edificio a soddisfare i requisiti dei Green Building Rating Systems, ad es. LEED®, BREEAM®, DGNB

Questo articolo non include la doccetta!

Sistema di sicurezza antiriflusso.

Questo articolo non include la doccetta!

Sistema di sicurezza antiriflusso.

	Cromato	34 458 892-00
	Platinato spazzolato	34 458 892-06
	Platinato	34 458 892-08
	Dark Chrome	34 458 892-19
	Ottone spazzolato (Oro 23k)	34 458 892-28
	Nero opaco	34 458 892-33
	Champagne spazzolato (Oro 22k)	34 458 892-46
	Champagne (Oro 22k)	34 458 892-47
	Cromo spazzolato	34 458 892-93
	Dark Platinum spazzolato	34 458 892-99

ST 050 302 4892

Prodotti complementari necessari

	Doccetta - Cromato	28 016 979-00
---	---------------------------	---------------

Prodotti complementari necessari

	Doccetta - Cromato	28 016 979-00
---	---------------------------	---------------

Prodotti complementari necessari

	Doccetta - Cromato	28 012 979-00
---	---------------------------	---------------

Prodotti complementari necessari

	Doccetta FlowReduce - Cromato	28 016 979-00 0010
---	--------------------------------------	-----------------------

Prodotti complementari necessari

	Doccetta FlowReduce - Cromato	28 016 979-00 0010
---	--------------------------------------	-----------------------

Prodotti complementari necessari

	Doccetta - Cromato	28 017 979-00
---	---------------------------	---------------

Prodotti complementari necessari

	Doccetta FlowReduce - Cromato	28 012 979-00 0010
---	--------------------------------------	-----------------------

Prodotti complementari necessari

	Doccetta - Cromato	28 018 979-00
---	---------------------------	---------------

Prodotti complementari necessari

	Doccetta FlowReduce - Cromato	28 018 979-00 0010
---	--------------------------------------	-----------------------

Prodotti complementari necessari

	SERIE NEUTRO Doccetta - Cromato	28 029 979-00
---	--	---------------

Prodotti complementari necessari

	SERIE NEUTRO Doccetta - Cromato	28 029 979-00
---	--	---------------

Prodotti complementari necessari

	SERIE NEUTRO Doccetta - Cromato	28 027 979-00 0010
---	--	-----------------------

Prodotti complementari necessari

	SERIE NEUTRO Doccetta - Cromato	28 029 979-00 0010
---	--	-----------------------

Prodotti complementari necessari

	SERIE NEUTRO Doccetta - Cromato	28 029 979-00 0010
---	--	-----------------------

Prodotti complementari necessari

	SERIE NEUTRO Doccetta - Cromato	28 025 979-00 0010
---	--	-----------------------

ST 050 302 4892



Diagramma di portata



Certificati

Belgaqua_22_283_2 WRAS_2204013. LGA_38737.
7_8.

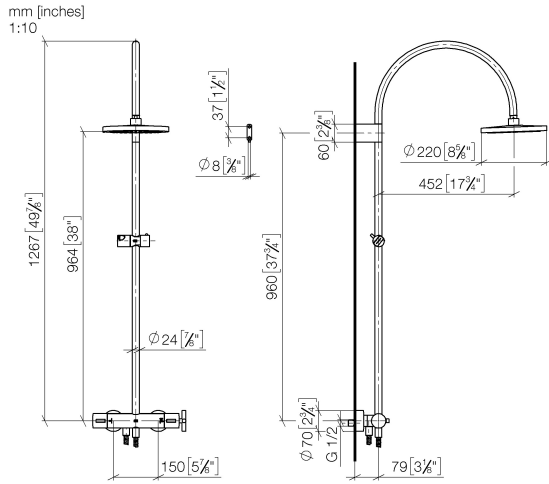
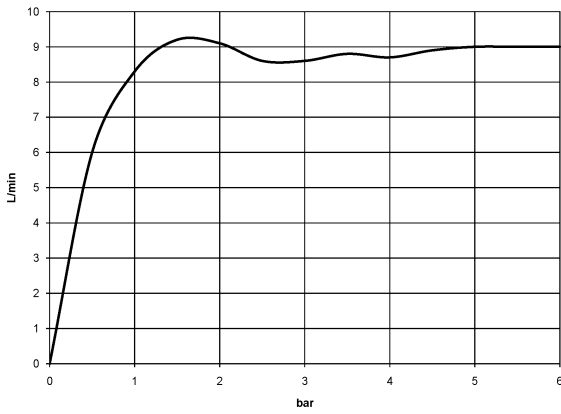
ST 050 302 4892

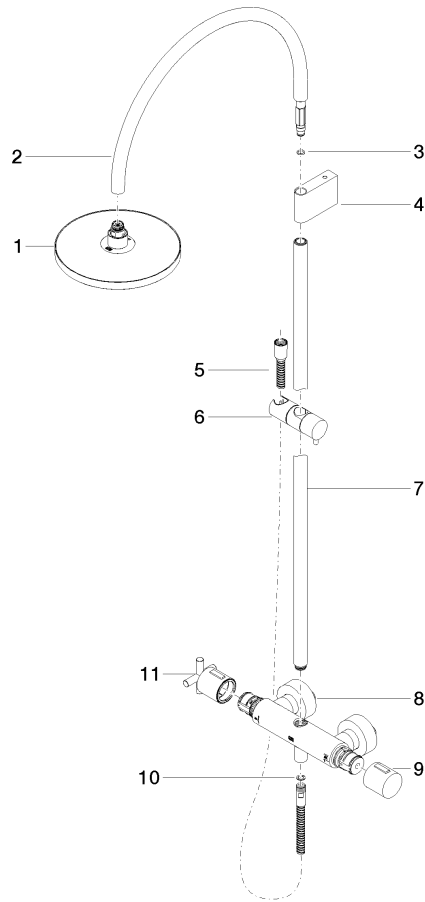

Elenco delle parti di ricambio

N.	Codice articolo	Denominazione	Quantità necessaria	Tempo di produzione
1	90 12 05 092 20-00	doccia	1	10
2	04 28 22 346 00-00	tubo	1	10
3	09 14 10 008 90	guarnizione	1	2
4	90 17 11 150 00-00	sostegno	1	10
5	28 322 970-00	Flessibile metallico per doccetta 1/2" x 3/8" x 1750 mm - Cromato	1	2
6	12 570 970-00	Supporto scorrevole - Cromato	1	10
7	90 28 22 349 00-00	tubo	1	10
8	04 17 01 250 00-00	attacco	1	10
9	90 17 33 015 00-00	manopola	1	10
10	90 14 20 026 00 90	guarnizione	1	2
11	90 17 33 021 00-00	manopola	1	10