

WATER FALL Cascade spout with individual jets for wall mounting - Chrome







IMO

13 425 979



- 22mm projection
- PEARLSTREAM
- plate 240 mm x 60 mm
- connection 1/2", for shortening
- plug-link mounting
- Max. flow rate 9.5 l/min (at 3 bar)

Fits: IMO, LULU, MADISON, MEM, TARA, CL.1, LISSÉ, VAIA, META, CYO

| | | |
|-------------------------------------------------------------------------------------|-------------------------------------|---------------|
|  | Chrome | 13 425 979-00 |
|  | Brushed Platinum | 13 425 979-06 |
|  | Platinum | 13 425 979-08 |
|  | Dark Chrome | 13 425 979-19 |
|  | Light Gold | 13 425 979-26 |
|  | Brushed Light Gold | 13 425 979-27 |
|  | Brushed Durabrass (23kt Gold) | 13 425 979-28 |
|  | Matte Black | 13 425 979-33 |
|  | Brushed Bronze | 13 425 979-42 |
|  | Brushed Champagne (22kt Gold) | 13 425 979-46 |
|  | Champagne (22kt Gold) | 13 425 979-47 |
|  | Brushed Chrome | 13 425 979-93 |
|  | Brushed Dark Platinum | 13 425 979-99 |

Recommended miscellaneous



Concealed wall elbow - 35 085 970 90
 •max. recess depth 163 mm
 •min. recess depth 90 mm

Recommended miscellaneous



Concealed wall elbow - 35 085 970 90
 •max. recess depth 163 mm
 •min. recess depth 90 mm

13 425 979

mm [inches]

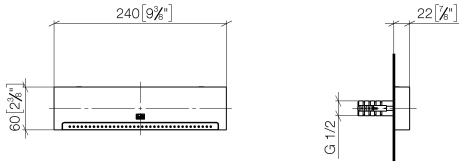

Flow rate chart

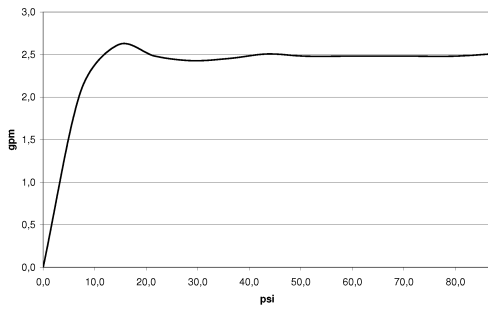

Trajectory diagram

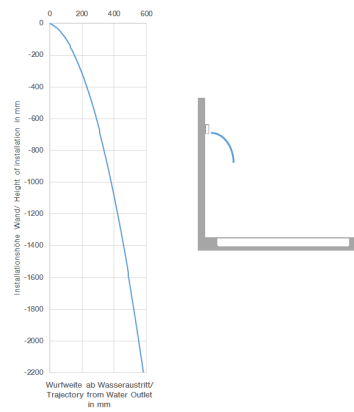

Certificates

LGA_19935.

IAPMO_4976 (6).

13 425 979

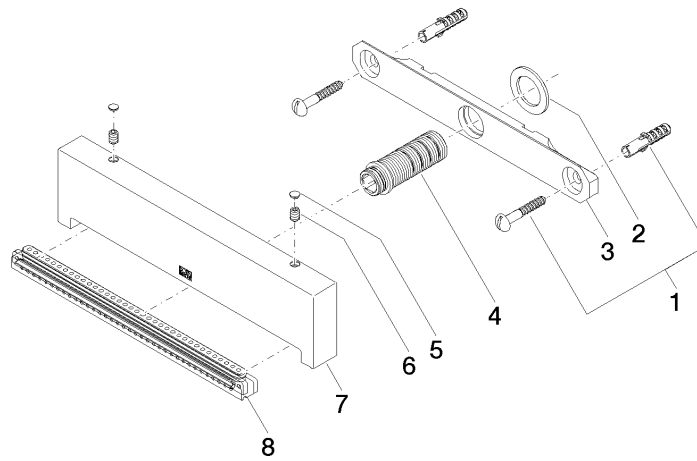

Spare parts list

| No. | Item Number | Name | Quantity used | Delivery time |
|-----|--------------------|------------|---------------|---------------|
| 1 | 04 30 31 024 01 90 | fixing set | 1 | 2 |
| 2 | 09 14 05 009 90 | seal | 1 | 2 |
| 3 | 09 17 97 053 90 | holder | 1 | 2 |
| 4 | 90 24 03 199 00 90 | connection | 1 | 2 |
| 5 | 90 31 20 087 00-00 | plug | 1 | 10 |
| 6 | 09 31 11 144 90 | pin | 2 | 2 |
| 8 | 90 29 03 071 00 90 | insert | 1 | 2 |