







CYO Wall-mounted basin spout without pop-up waste - Chrome

CYO

13 800 811



- 160mm projection
- fixed spout
- rectangular, air-enriched flow
- hole diameter 37 mm
- 1/2" connection
- max. flow 4.5 l/min
- lead-free
- This product can help a building meet the requirements of Green Building Rating Systems, e.g. LEED®, BREEAM®, DGNB

| | | |
|---|---|---------------|
|  | Chrome | 13 800 811-00 |
|  | Brushed Platinum | 13 800 811-06 |
|  | Dark Chrome | 13 800 811-19 |
|  | Brushed Durabronze (23kt Gold) | 13 800 811-28 |
|  | Platinum / Brushed Platinum | 13 800 811-36 |
|  | Durabronze / Brushed Durabronze (23kt Gold) | 13 800 811-38 |
|  | Brushed Dark Platinum | 13 800 811-99 |

Recommended miscellaneous



- Concealed wall elbow -** 35 085 970 90
- max. recess depth 163 mm
 - min. recess depth 90 mm

13 800 811

mm [inches]

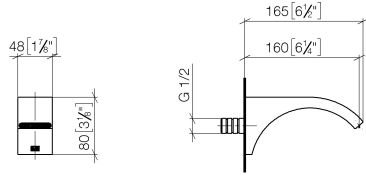

Flow rate chart

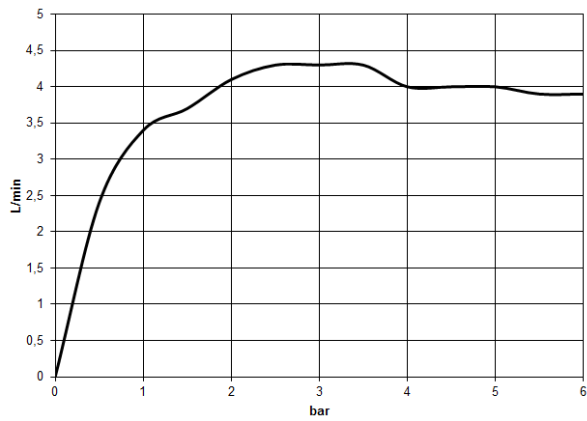

Certificates

LGA_38116. IAPMO_8834 (2). IAPMO_N-4976. IAPMO_4976 (6). IAPMO_6397.

13 800 811

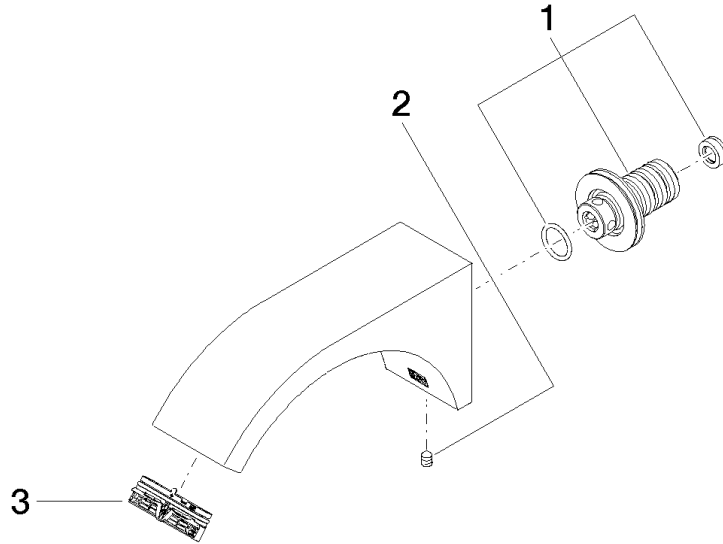

Spare parts list

| No. | Item Number | Name | Quantity used | Delivery time |
|-----|--------------------|------------|---------------|---------------|
| 1 | 90 24 03 108 01 90 | nipple set | 1 | 2 |
| 2 | 90 31 11 004 00 90 | pin | 1 | 2 |
| 3 | 90 29 03 121 00 90 | aerator | 1 | 2 |