









28 017 979



- COMPACT RAIN, max. flow rate 15 l/min (at 3 bar)
- with anti-scale system
- spray head Ø 130 mm
- 1/2" connection
- WRAS 2009011

Intrinsic protection against back flow.

Fits: IMO, LULU, MADISON, MEM, TARA,  
CL.1, LISSÉ, VAIA, META, CYO

	Brushed Chrome	28 017 979-93
	Chrome	28 017 979-00 0050
	Brushed Platinum	28 017 979-06 0050
	Platinum	28 017 979-08 0050
	Matte White	28 017 979-10 0050
	Dark Chrome	28 017 979-19 0050
	Light Gold	28 017 979-26 0050
	Brushed Light Gold	28 017 979-27 0050
	Brushed Durabronze (23kt Gold)	28 017 979-28 0050
	Matte Black	28 017 979-33 0050
	Brushed Bronze	28 017 979-42 0050
	Brushed Champagne (22kt Gold)	28 017 979-46 0050
	Champagne (22kt Gold)	28 017 979-47 0050
	Brushed Chrome	28 017 979-93 0050
	Brushed Dark Platinum	28 017 979-99 0050

28 017 979

mm [inches]

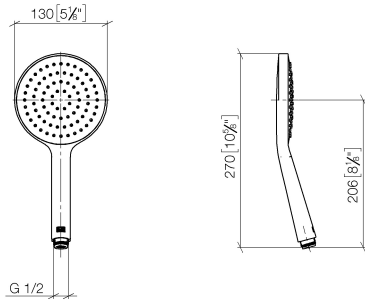

Flow rate chart



Codes & Standards

DIN 4109

EN 1112

ISO 3822

Scottish Water  
Byelaws

UK Water Supply  
Regulations

Ü-Zeichen



## Hand shower - Brushed Chrome

IMO

28 017 979

### Certificates

WRAS\_2009

DVGW\_DW-  
6517DN0

LGA\_29

28 017 979

**Product version from 4/1/2024**

Parts for other  
finishes can be found  
here: [Chrome](#)

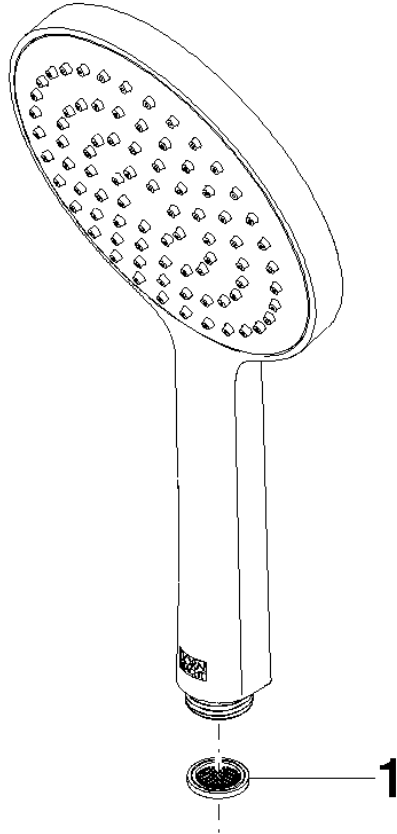



# Hand shower - Brushed Chrome

IMO

28 017 979

## Spare parts list

### Product version from 4/1/2024

No.	Item Number	Name	Quantity used	Delivery time
	09 23 01 039 90	sieve	1	2