

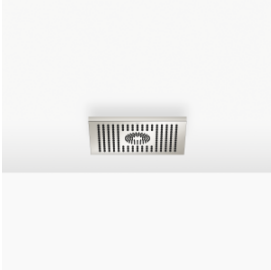











28 041 980



Fits: IMO, LULU, MEM, CL.1, CYO

- rain shower 300 x 240mm
 - PURE RAIN, max. flow rate 6.8 l/min (at 3 bar)
 - PURIFY RAIN, max. flow rate 6.8 l/min (at 3 bar)
 - Distance to ceiling from bottom edge of shower 40 mm
 - with anti-scale system
 - For simultaneous control of the jet types, we recommend the xTool thermostat module
 - This product can help a building meet the requirements of Green Building Rating Systems, e.g. LEED®, BREEAM®, DGNB
- Three-way diverter trim is sold separately**

Three-way diverter trim is sold separately

	Platinum	28 041 980-08 0050
	Chrome	28 041 980-00 0050
	Brushed Platinum	28 041 980-06 0050
	Dark Chrome	28 041 980-19 0050
	Brushed Light Gold	28 041 980-27 0050
	Brushed Durabronze (23kt Gold)	28 041 980-28 0050
	Matte Black	28 041 980-33 0050
	Brushed Champagne (22kt Gold)	28 041 980-46 0050
	Champagne (22kt Gold)	28 041 980-47 0050
	Brushed Chrome	28 041 980-93 0050
	Brushed Dark Platinum	28 041 980-99 0050

Required miscellaneous



Concealed ceiling installation box 35 041 970 90
with ceiling fixing -

- min. recess depth 90 mm
- max. recess depth 115 mm
- 2x female thread 1/2" outlet
- concealed rough parts

28 041 980

mm [inches]

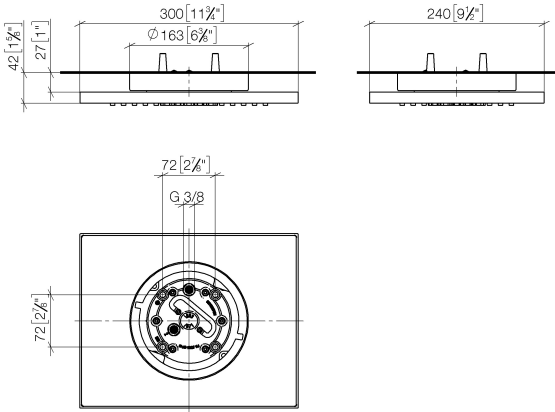

Flow rate chart

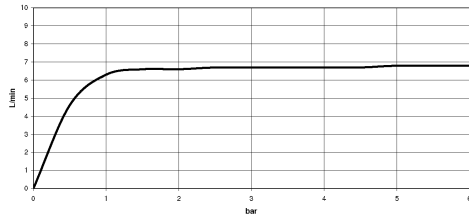

28 041 980

Product version from 7/1/2022

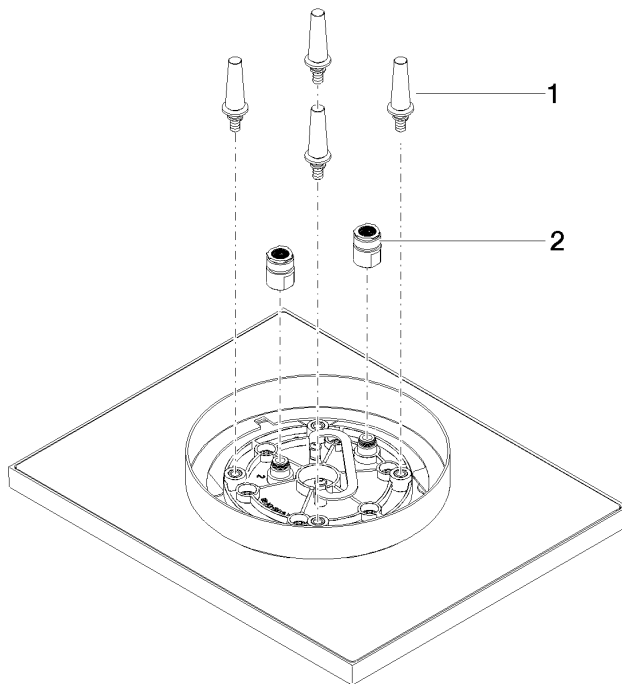



Rain shower for surface-mounted ceiling installation 300 x 240 mm - Platinum

IMO

28 041 980

Spare parts list

Product version from 7/1/2022

No.	Item Number	Name	Quantity used	Delivery time
	90 17 20 263 00 90	fixing set	2	2