







28 450 845



- 3/8" shower outlet
- rosette 60 x 78 mm
- 1/2" connection
- WRAS 2310091

Intrinsic protection against back flow.

| | | |
|---|-----------------------|---------------|
|  | Matte Black | 28 450 845-33 |
|  | Chrome | 28 450 845-00 |
|  | Brushed Platinum | 28 450 845-06 |
|  | Dark Chrome | 28 450 845-19 |
|  | Brushed Light Gold | 28 450 845-27 |
|  | Brushed Chrome | 28 450 845-93 |
|  | Brushed Dark Platinum | 28 450 845-99 |

Recommended miscellaneous

- Concealed wall elbow -** 35 085 970 90
- max. recess depth 163 mm
 - min. recess depth 90 mm



28 450 845

mm [inches]



Flow rate chart

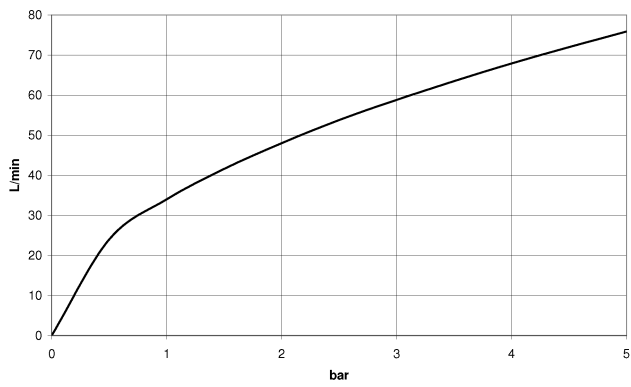

Certificates

WRAS_2310091.

28 450 845

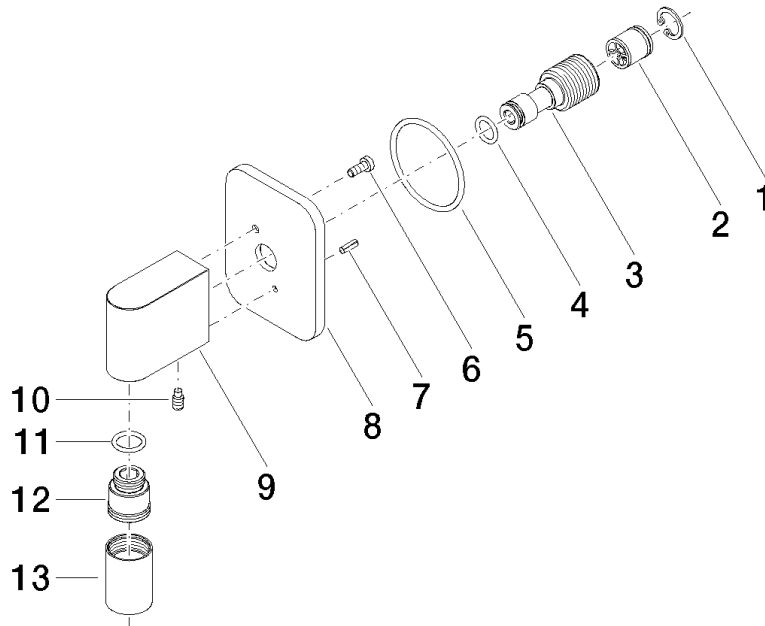

Spare parts list

| No. | Item Number | Name | Quantity used | Delivery time |
|-----|--------------------|---------------------|---------------|---------------|
| 1 | 09 16 01 014 90 | ring | 1 | 2 |
| 2 | 90 23 01 141 00 90 | back-flow preventer | 1 | 2 |
| 3 | 09 24 03 116 20 90 | nipple | 1 | 2 |
| 4 | 09 14 10 008 90 | seal | 1 | 2 |
| 5 | 09 14 10 142 90 | seal | 1 | 2 |
| 6 | 09 30 30 054 90 | screw | 1 | 2 |
| 7 | 09 31 11 026 90 | pin | 1 | 2 |
| 8 | 09 27 84 021-33 | rosette | 1 | 30 |
| 9 | 09 11 03 046-33 | connection | 1 | 30 |
| 10 | 09 31 11 005 90 | pin | 1 | 2 |
| 11 | 90 14 10 077 00 90 | seal | 1 | 2 |
| 12 | 09 24 03 107 20 90 | nipple | 1 | 2 |
| 13 | 90 21 02 069 00-33 | cover | 1 | 30 |