

Rain shower with wall fixing 300 mm - Brushed Platinum















TARA

28 679 970



- 450mm projection
- rain shower Ø 300 mm
- PURE RAIN, max. flow rate 14 l/min (at 3 bar)
- rosette Ø 60 mm
- 1/2" connection
- with anti-scale system
- quick clearing
- This product can help a building meet the requirements of Green Building Rating Systems, e.g. LEED®, BREEAM®, DGNB

Fits: TARA, LISSÉ, VAIA, META

	Brushed Platinum	28 679 970-06 0050
	Chrome	28 679 970-00 0050
	Platinum	28 679 970-08 0050
	Dark Chrome	28 679 970-19 0050
	Light Gold	28 679 970-26 0050
	Light Gold	28 679 970-26
	Brushed Light Gold	28 679 970-27 0050
	Brushed Light Gold	28 679 970-27
	Brushed Durabronze (23kt Gold)	28 679 970-28 0050
	Matte Black	28 679 970-33 0050
	Brushed Bronze	28 679 970-42 0050
	Brushed Champagne (22kt Gold)	28 679 970-46 0050
	Champagne (22kt Gold)	28 679 970-47 0050
	Brushed Chrome	28 679 970-93 0050
	Brushed Dark Platinum	28 679 970-99 0050

28 679 970

mm [inches]

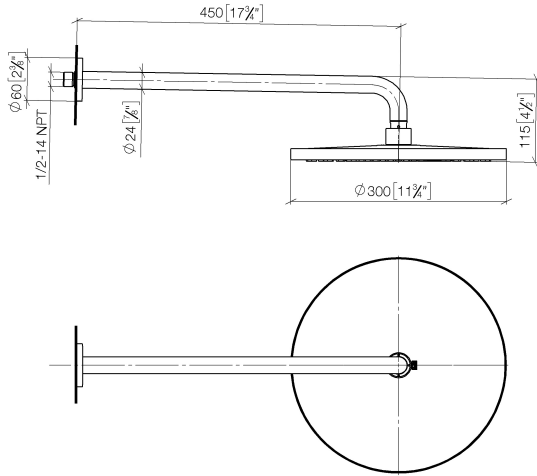

Flow rate chart



28 679 970

Parts for other finishes can be found here: [Chrome](#)

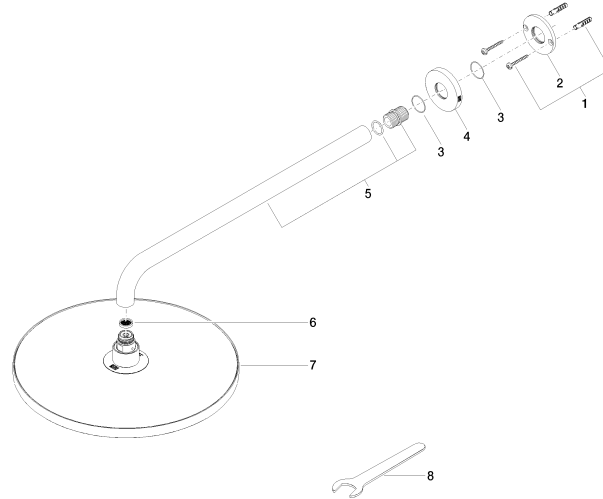

Spare parts list

No.	Item Number	Name	Quantity used	Delivery time
1	04 30 31 032 00 90	fixing set	1	2
2	09 17 20 120 90	holder	1	2
3	09 14 10 150 90	seal	2	2
4	09 27 97 015-06	rosette	1	10
5	90 11 03 070 00-06	pipe	1	10
6	09 23 01 075 90	insert	1	2
7	04 12 05 091 10-06	shower	1	10
8	90 30 09 069 00 90	key	1	2