











**META Wall-mounted valve cold water without pop-up waste - Champagne (22kt Gold)**

META

30 010 662



- 126mm projection
- fixed spout
- circular, air-enriched flow
- hole diameter 35 mm
- rosette Ø 60 mm
- max. flow 5.7 l/min
- lead-free
- This product can help a building meet the requirements of Green Building Rating Systems, e.g. LEED®, BREEAM®, DGNB

|   |                               |               |
|---|-------------------------------|---------------|
|    | Champagne (22kt Gold)         | 30 010 662-47 |
|    | Chrome                        | 30 010 662-00 |
|    | Brushed Platinum              | 30 010 662-06 |
|    | Dark Chrome                   | 30 010 662-19 |
|    | Light Gold                    | 30 010 662-26 |
|    | Brushed Light Gold            | 30 010 662-27 |
|    | Matte Black                   | 30 010 662-33 |
|    | Brushed Bronze                | 30 010 662-42 |
|    | Brushed Champagne (22kt Gold) | 30 010 662-46 |
|  | Brushed Chrome                | 30 010 662-93 |
|  | Brushed Dark Platinum         | 30 010 662-99 |

30 010 662  
mm [inches]

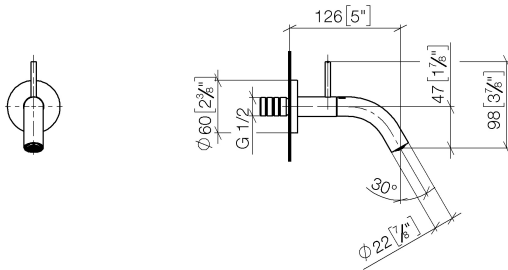

**Flow rate chart**



**Certificates**

LGA\_38414.

30 010 662  
Parts for other  
finishes can be found  
here: Chrome

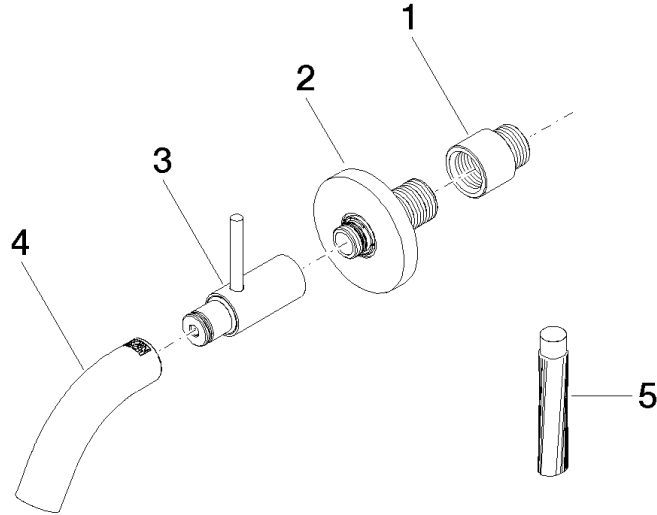

**Spare parts list**

| No. | Item Number        | Name    | Quantity used | Delivery time |
|-----|--------------------|---------|---------------|---------------|
| 1   | 09 24 03 072 10 90 | nipple  | 1             | 2             |
| 2   | 90 27 66 019 00-47 | rosette | 1             | 30            |
| 3   | 90 20 66 023 00-47 | handle  | 1             | 30            |
| 4   | 90 28 22 385 00-47 | spout   | 1             | 30            |
| 5   | 09 16 03 001 90    | grease  | 1             | 2             |