











33 815 861



- 235mm projection
- pivotable spout 360°
- Optional swivel limiter available with swivel limiter set 12 820 970 90
- air-enriched flow
- max. flow 8 l/min at 3 bar flow pressure
- lead-free
- This product can help a building meet the requirements of Green Building Rating Systems, e.g. LEED®, BREEAM®, DGNB
- WRAS 240102021

	Brushed Champagne (22kt Gold)	33 815 861-46
	Chrome	33 815 861-00
	Brushed Platinum	33 815 861-06
	Platinum	33 815 861-08
	Durabronze (23kt Gold)	33 815 861-09
	Dark Chrome	33 815 861-19
	Brushed Durabronze (23kt Gold)	33 815 861-28
	Matte Black	33 815 861-33
	Champagne (22kt Gold)	33 815 861-47
	Brushed Chrome	33 815 861-93
	Brushed Dark Platinum	33 815 861-99

Recommended miscellaneous



**Swivel limitation set -** 12 820 970 90

Recommended miscellaneous



**Dispenser without rosette -  
Brushed Champagne (22kt Gold)** 82 424 970-46

Recommended miscellaneous



**Strainer waste with control handle  
- Brushed Champagne (22kt Gold)** 10 712 970-46

33 815 861

mm [inches]

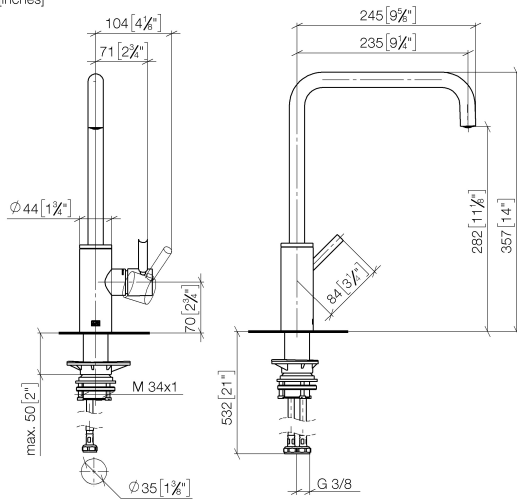

**Flow rate chart**



**Certificates**

LGA\_38642.

WRAS\_240102021.

33 815 861



**Spare parts list**

No.	Item Number	Name	Quantity used	Delivery time
1	90 28 22 284 00-46	spout	1	30
2	90 15 05 042 00 90	cartridge	1	2
3	09 24 04 266 90	nut	1	2
4	90 28 30 052 00-46	cover	1	30
5	90 20 66 033 00-46	handle	1	30
6	04 23 10 044 08 90	fixing set	1	2
7	04 30 04 101 00 90	hose	2	2