







34 459 360



- shower with fixed riser projection 420mm
- rain shower Ø 200 mm
- rain shower with anti-scale system
- max. rainshower flow 14 l/min
- rotary diverter for fixed-riser shower/hand shower
- height of fittings up to rain shower (bottom edge) 985mm
- height of fittings up to top edge of elbow 1160mm
- two-part push-on rosette Ø 65 mm
- rosette for shower holder Ø 65mm
- rosette for wall mounting Ø 60mm
- gauge 150 mm - 13 mm
- metal shower hose 1250mm with integrated anti-twist protection
- 1/2" connection
- Pipe diameter 20 mm
- This product can help a building meet the requirements of Green Building Rating Systems, e.g. LEED®, BREEAM®, DGNB

This article does not include a hand shower!

Intrinsic protection against back flow.

	Chrome	34 459 360-00 0050
	Brushed Platinum	34 459 360-06 0050
	Platinum	34 459 360-08 0050
	Durabrace (23kt Gold)	34 459 360-09 0050
	Brushed Durabrace (23kt Gold)	34 459 360-28 0050
	Brushed Dark Platinum	34 459 360-99 0050

34 459 360

Parts for other finishes can be found here: Brushed Platinum

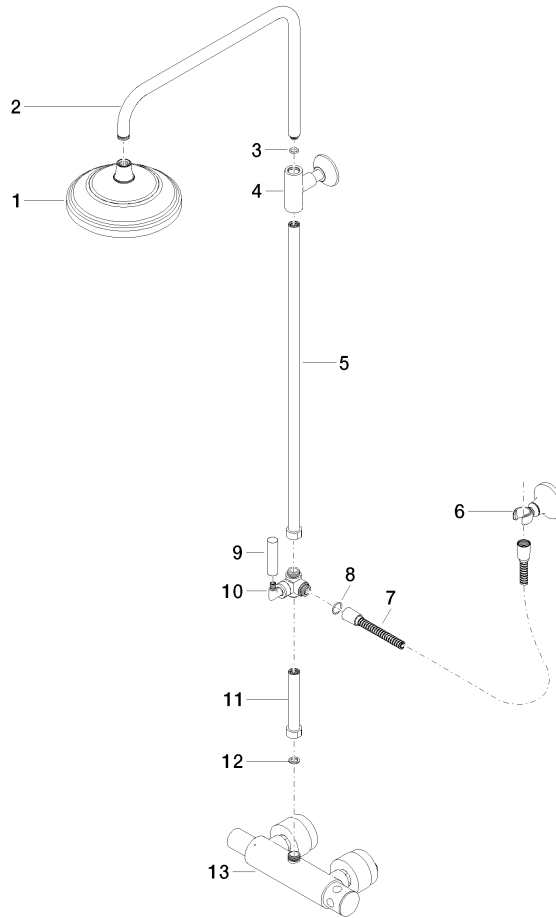

Spare parts list

No.	Item Number	Name	Quantity used	Delivery time
1	90 12 05 038 20-00	shower	1	10
2	04 28 22 101 20-00	spout	1	10
3	90 14 10 011 00 90	seal	1	2
4	90 17 11 037 01-00	holder	1	10
5	90 28 22 104 00-00	pipe	1	10
6	90 17 09 045 01-00	diverter	1	10
7	09 30 30 064-00	screw	1	10
8	09 18 20 011-00	base	1	10
9	09 28 22 013 90	pipe	1	2
10	11 170 370-00	MADISON Lever insert - Chrome	1	10
11	09 30 30 062-00	screw	1	10
12	09 14 10 122 90	seal	1	2
13	28 104 970-00	Metal shower hose 1/2" x 1/2" x 1250 mm - Chrome	1	2
14	28 050 410-00	holder	1	60
15	90 28 22 103 00-00	pipe	1	10
16	90 14 20 002 00 90	seal	1	2
17	04 17 01 044 01-00	fitting	1	10