











VAIA Shower pipe with shower thermostat without hand shower - Brushed Durabronze (23kt Gold)

34 459 809 Product version from 4/1/2024



- shower with fixed riser projection 452mm
- overhead shower: rain flow
- rain shower Ø 220 mm
- rain shower with anti-scale system
- max. rainshower flow 14 l/min
- rotary diverter with volume control and shut-off function
- slide-on rosettes Ø 70 mm
- height of fittings up to rain shower (bottom edge) 964mm
- height of fittings up to top edge of elbow 1267mm
- gauge 150 mm - 13 mm
- metal shower hose 1750mm with integrated anti-twist protection
- 1/2" connection
- slide bar
- Pipe diameter 23.5 mm
- This product can help a building meet the requirements of Green Building Rating Systems, e.g. LEED®, BREEAM®, DGNB

	Brushed Durabronze (23kt Gold)	34 459 809-28 0050
	Chrome	34 459 809-00 0050
	Brushed Platinum	34 459 809-06 0050
	Platinum	34 459 809-08 0050
	Dark Chrome	34 459 809-19 0050
	Brushed Light Gold	34 459 809-27 0050
	Brushed Bronze	34 459 809-42 0050
	Brushed Champagne (22kt Gold)	34 459 809-46 0050
	Champagne (22kt Gold)	34 459 809-47 0050
	Brushed Dark Platinum	34 459 809-99 0050



VAIA Shower pipe with shower thermostat without hand shower - Brushed Durabronz (23kt Gold)

34 459 809 Product version from 4/1/2024

Flow rate chart

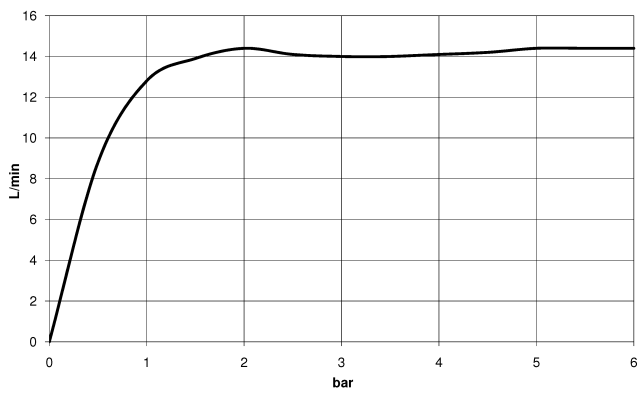

VAIA Shower pipe with shower thermostat without hand shower - Brushed Durabronz (23kt Gold)

34 459 809 Product version from 4/1/2024

Parts for other finishes can be found here: [Chrome](#)

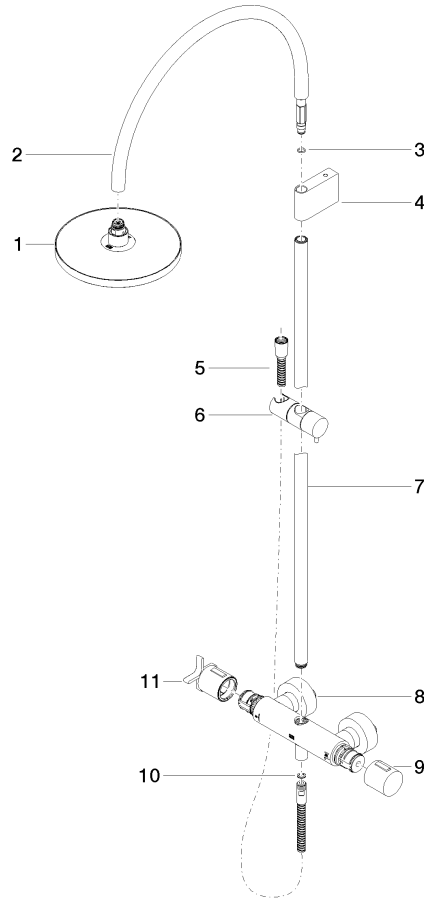

Spare parts list

No.	Item Number	Name	Quantity used	Delivery time
	1 90 12 05 092 00-28	90120509200-28	1	20
	2 04 28 22 346 00-28	pipe	1	20
	3 09 14 10 008 90	seal	1	2
	4 90 17 11 150 00-28	holder	1	20
	5 28 322 970-28	Metal shower hose 1/2" x 3/8" x 1750 mm - Brushed Durabronz (23kt Gold)	1	20
	6 12 570 970-28	Slide unit - Brushed Durabronz (23kt Gold)	1	20
	7 90 28 22 349 00-28	pipe	1	20
	8 04 17 01 250 00-28	connection	1	20
	9 90 17 33 015 00-28	handle	1	20
	10 90 14 20 026 00 90	seal	1	2
	11 90 17 33 030 00-28	handle	1	20