









36 060 809

- cover plate 80 x 80 mm



	Brushed Bronze	36 060 809-42
	Chrome	36 060 809-00
	Brushed Platinum	36 060 809-06
	Platinum	36 060 809-08
	Dark Chrome	36 060 809-19
	Brushed Durabronze (23kt Gold)	36 060 809-28
	Brushed Champagne (22kt Gold)	36 060 809-46
	Champagne (22kt Gold)	36 060 809-47
	Brushed Dark Platinum	36 060 809-99

Required miscellaneous



**Concealed wall-mounted single-lever mixer -** 35 860 970 90

- min. recess depth 80 mm
- max. recess depth 95 mm



## VAIA Concealed single-lever mixer with cover plate - Brushed Bronze

---

VAIA

36 060 809

### Certificates

---

LGA\_29905.

36 060 809

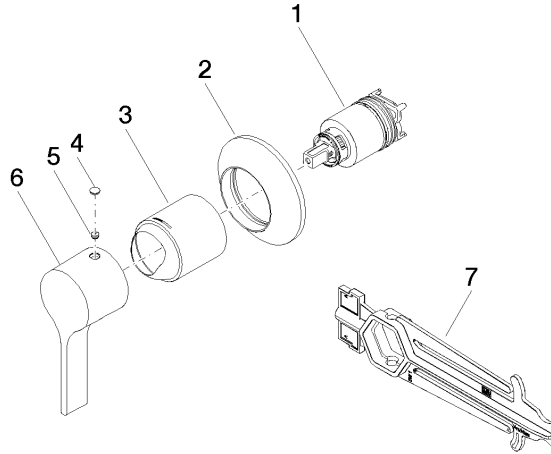

### Spare parts list

No.	Item Number	Name	Quantity used	Delivery time
1	90 15 05 064 01 90	cartridge	1	2
2	90 27 80 032 00-42	rosette	1	30
3	09 11 02 293-42	cover	1	60
4	90 31 20 087 00-42	plug	1	30
5	90 31 11 063 00 90	pin	1	2
6	09 20 80 021-42	handle	1	60
7	90 30 09 064 00 90	key	1	2