



EDITION PRO Concealed single-lever mixer with diverter - Matte Black

36 120 626



- automatic diverter
- cover plate Ø 150 mm
- WRAS 2207012

	Matte Black	36 120 626-33
	Chrome	36 120 626-00
	Brushed Chrome	36 120 626-93

Required miscellaneous



EDITION PRO Concealed single-lever mixer - 35 070 970 90
 •max. recess depth 105 mm
 •min. recess depth 80 mm

Required miscellaneous

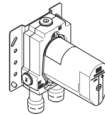

EDITION PRO Concealed single-lever mixer with backflow preventor - 35 071 970 90
 •max. recess depth 105 mm
 •min. recess depth 80 mm

EDITION PRO Concealed single-lever mixer with diverter - Matte Black

36 120 626

mm [inches]

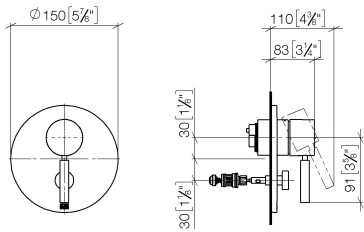

Flow rate chart

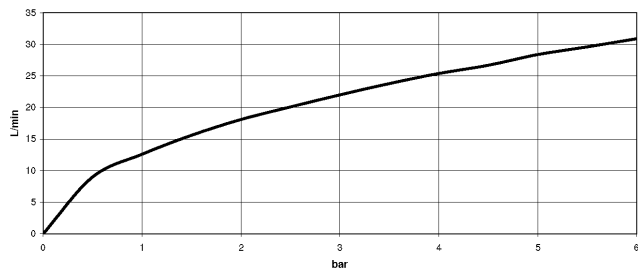

Certificates

LGA_19863.

WRAS_2207012.

EDITION PRO Concealed single-lever mixer with diverter - Matte Black

36 120 626

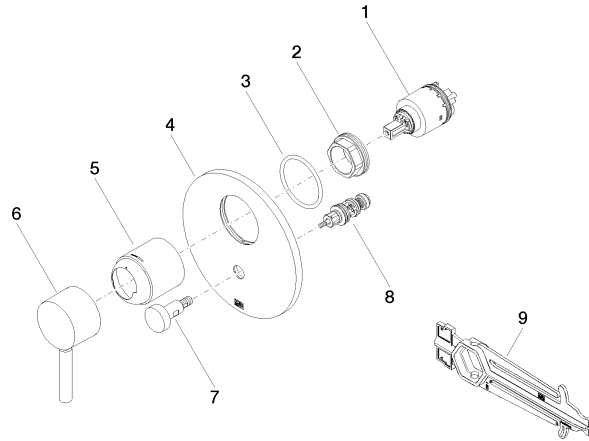

Spare parts list

No.	Item Number	Name	Quantity used	Delivery time
1	90 15 05 039 00 90	cartridge	1	2
2	09 24 04 448 90	nut	1	2
3	09 14 10 084 90	seal	1	2
4	09 11 02 261-33	plate	1	30
5	09 11 02 360-33	cover	1	30
6	90 20 66 004 00-33	handle	1	30
7	90 31 09 139 00-33	pull-rod	1	30
8	90 21 34 081 00 90	diverter	1	2
9	90 30 09 064 00 90	key	1	2