











36 200 661



- rotary diverter
- without rosette
- handle Ø 60mm
- WRAS 2307045

	Brushed Dark Platinum	36 200 661-99
	Chrome	36 200 661-00
	Brushed Platinum	36 200 661-06
	Dark Chrome	36 200 661-19
	Light Gold	36 200 661-26
	Brushed Light Gold	36 200 661-27
	Matte Black	36 200 661-33
	Brushed Bronze	36 200 661-42
	Brushed Champagne (22kt Gold)	36 200 661-46
	Champagne (22kt Gold)	36 200 661-47
	Brushed Chrome	36 200 661-93

Required miscellaneous



- Concealed two-way diverter -** 35 202 970 90
- min. recess depth 115 mm
  - max. recess depth 160 mm

36 200 661

mm [inches]

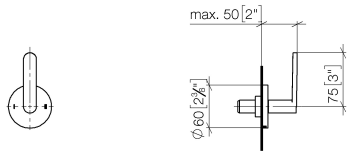

**Flow rate chart**

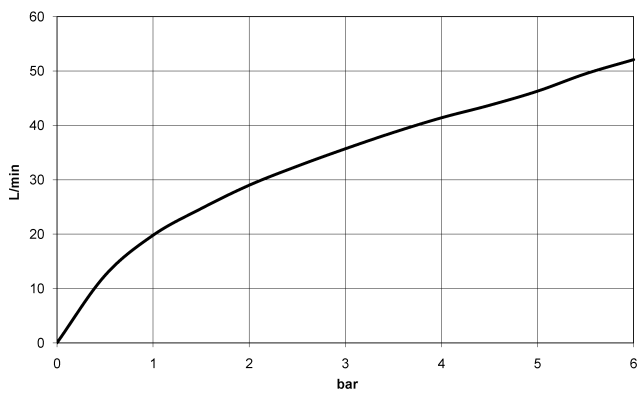

**Certificates**

LGA\_38379.

WRAS\_2307045.

36 200 661

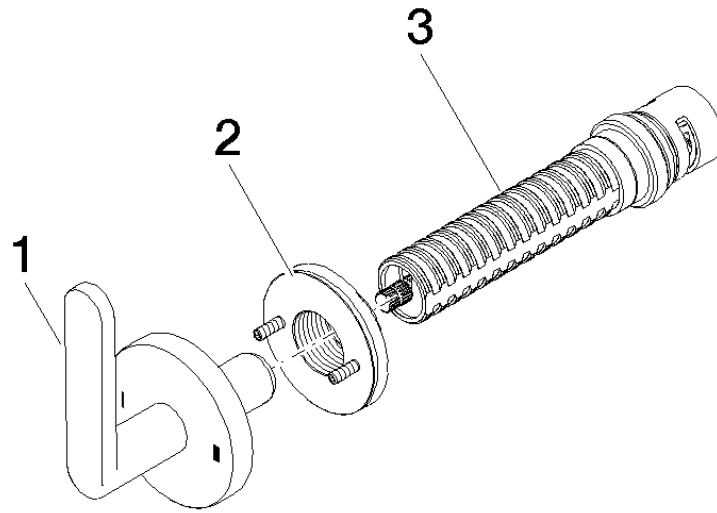

**Spare parts list**

No.	Item Number	Name	Quantity used	Delivery time
1	90 20 66 014 00-99	handle	1	30
2	90 21 02 181 00 90	disc	1	2
3	90 90 03 304 10 90	diverter	1	2