

Concealed two-way diverter - Brushed Platinum











CL.1

36 200 740



- rotary diverter
- without rosette
- handle Ø 60mm
- WRAS 2307045

Fits: CL.1, META, CYO

| | | |
|---|-------------------------------------|---------------|
|  | Brushed Platinum | 36 200 740-06 |
|  | Chrome | 36 200 740-00 |
|  | Light Gold | 36 200 740-26 |
|  | Brushed Light Gold | 36 200 740-27 |
|  | Brushed Durabrass (23kt Gold) | 36 200 740-28 |
|  | Matte Black | 36 200 740-33 |
|  | Brushed Bronze | 36 200 740-42 |
|  | Brushed Champagne (22kt Gold) | 36 200 740-46 |
|  | Champagne (22kt Gold) | 36 200 740-47 |
|  | Brushed Dark Platinum | 36 200 740-99 |

Required miscellaneous



- Concealed two-way diverter -** 35 202 970 90
- max. recess depth 160 mm
 - min. recess depth 85 mm

36 200 740

mm [inches]

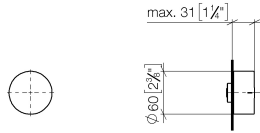

Flow rate chart



Certificates

LGA_38379.

WRAS_2307045.

36 200 740

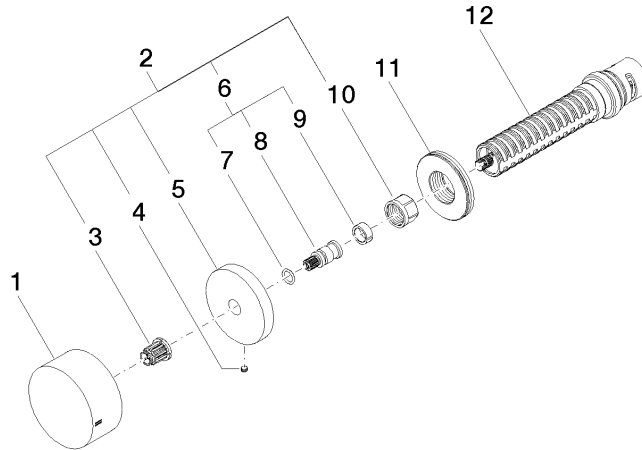

Spare parts list

| No. | Item Number | Name | Quantity used | Delivery time |
|--|--------------------|------------|---------------|---------------|
| 1 | 09 20 74 044-06 | handle | 1 | 60 |
| 2 | 04 27 74 004 00-06 | rosette | 1 | 10 |
| 3 | 90 12 12 002 00 90 | fixing cap | 1 | 2 |
| 4 | 09 31 11 055 90 | pin | 1 | 2 |
| 5 | 09 27 74 004-06 | rosette | 1 | 10 |
| 6 | 04 29 06 020 00-00 | spindle | 1 | 10 |
| 7 | 90 14 10 060 00 90 | seal | 1 | 2 |
| 8 | 09 29 06 020-06 | spindle | 1 | - |
| Spare part can no longer be ordered, please order the replacement item | | | | |
| 9 | 90 14 15 020 03 90 | ring | 1 | 2 |
| 10 | 90 23 30 023 00 90 | nut | 1 | 2 |
| 11 | 09 30 01 107 90 | sleeve | 1 | 2 |
| 12 | 90 90 03 304 10 90 | diverter | 1 | 2 |