















36 503 979



- cover plate Ø 124 mm
- temperature control handle with safety limit stop at 38°C
- thermostat cartridge
- WRAS 2011026

	Chrome	36 503 979-00
	Brushed Platinum	36 503 979-06
	Platinum	36 503 979-08
	Durabronze (23kt Gold)	36 503 979-09
	Dark Chrome	36 503 979-19
	Light Gold	36 503 979-26
	Brushed Light Gold	36 503 979-27
	Brushed Durabronze (23kt Gold)	36 503 979-28
	Matte Black	36 503 979-33
	Brushed Bronze	36 503 979-42
	Brushed Champagne (22kt Gold)	36 503 979-46
	Champagne (22kt Gold)	36 503 979-47
	Brushed Chrome	36 503 979-93
	Brushed Dark Platinum	36 503 979-99

Required miscellaneous



xTOOL Concealed thermostat module without volume control - 35 503 970 90
 • max. recess depth 110 mm
 • min. recess depth 85 mm

Recommended miscellaneous



xGRID Attachment set for integrating in the dry wall construction - 12 340 970 90

Required miscellaneous



xGRID Installation track 555 mm - 12 360 970 90

36 503 979

mm [inches]

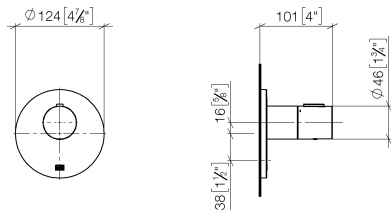

Flow rate chart



Certificates

WRAS_2011026.

DVGW_DW-
6512DN0706.

LGA_29930.

LGA_29932.

36 503 979

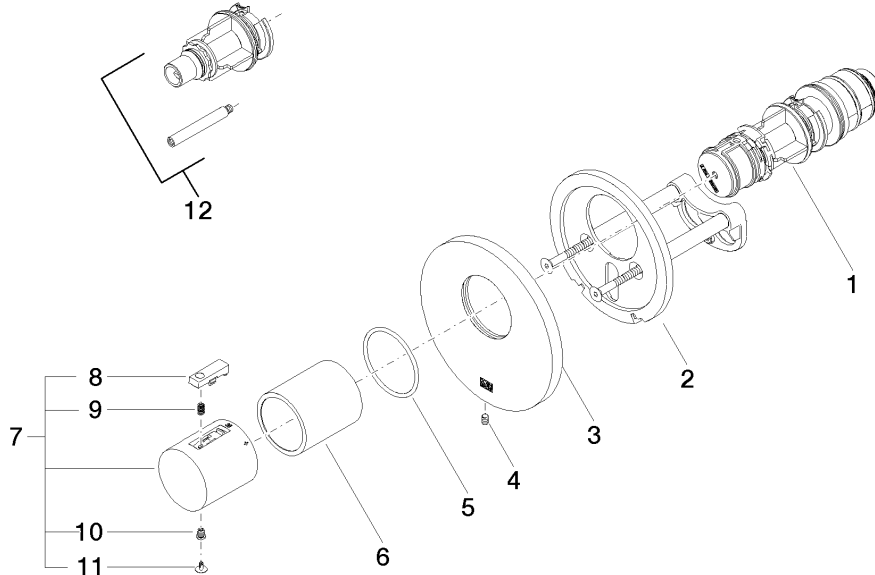

Spare parts list

No.	Item Number	Name	Quantity used	Delivery time
1	90 15 02 063 00 90	cartridge	1	2
2	90 11 01 196 00 90	base	1	2
3	09 11 02 537-00	cover	1	10
4	09 31 11 048 90	pin	1	2
5	90 14 10 049 00 90	seal	1	2
6	90 21 02 112 00-00	sleeve	1	10
7	90 17 33 004 00-00	handle	1	10
8	90 21 33 011 00-13	handle	1	2
9	90 16 02 027 00 90	spring	1	2
10	90 30 30 136 00 90	screw	1	2
11	90 31 20 049 00-00	plug	1	10
12	12 178 970 90	Extension 46 mm -	1	2