













36 512 979



- forceful flat water jet
- horizontal water jet
- cover plate 240 x 60 mm
- water jet adjustable
- 1/2" connection
- max. flow 6.8 l/min
- This product can help a building meet the requirements of Green Building Rating Systems, e.g. LEED®, BREEAM®, DGNB

Fits: IMO, LULU, MADISON, MEM, TARA, CL.1, LISSÉ, VAIA, META, CYO

	Brushed Bronze	36 512 979-42 0050
	Chrome	36 512 979-00 0050
	Brushed Platinum	36 512 979-06 0050
	Platinum	36 512 979-08 0050
	Dark Chrome	36 512 979-19 0050
	Light Gold	36 512 979-26 0050
	Brushed Light Gold	36 512 979-27 0050
	Brushed Durabronze (23kt Gold)	36 512 979-28 0050
	Matte Black	36 512 979-33 0050
	Brushed Champagne (22kt Gold)	36 512 979-46 0050
	Champagne (22kt Gold)	36 512 979-47 0050
	Brushed Chrome	36 512 979-93 0050
	Brushed Dark Platinum	36 512 979-99 0050

36 512 979

mm [inches]

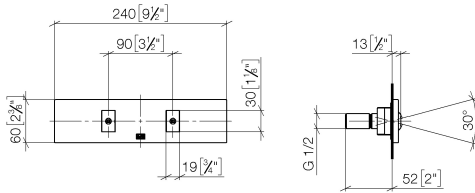

Flow rate chart



36 512 979

Parts for other finishes can be found here: [Chrome](#)

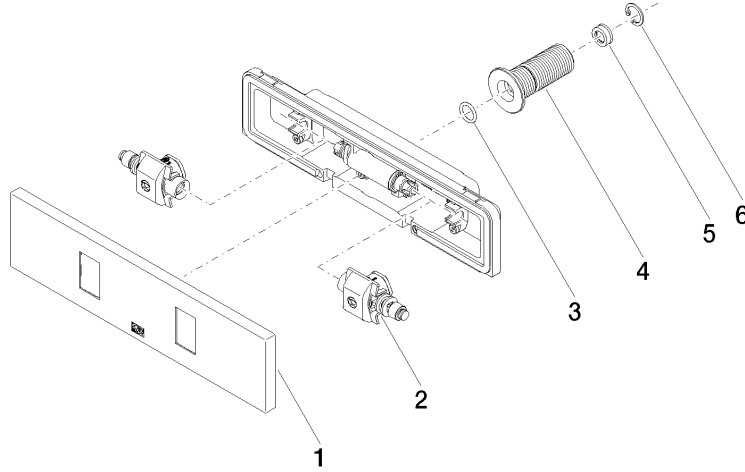

Spare parts list

No.	Item Number	Name	Quantity used	Delivery time
1	90 27 99 002 00-42	insert	1	30
2	90 31 10 012 00 90	insert	1	2
3	09 14 10 003 90	seal	1	2
4	09 24 05 015 90	nipple	1	2
5	09 23 01 165 90	flow reducer	1	2
6	09 16 01 014 90	ring	1	2