

WATER CURVE Concealed body spray - Brushed Chrome













IMO

36 514 979



- AQUAPRESSURE FLOW, max. flow rate 6.8 l/min (at 3 bar)
- water jet adjustable
- cover plate 120 x 60 mm
- 1/2" connection
- This product can help a building meet the requirements of Green Building Rating Systems, e.g. LEED®, BREEAM®, DGNB

Fits: IMO, LULU, MADISON, MEM, TARA, CL.1, LISSÉ, VAIA, META, CYO

	Brushed Chrome	36 514 979-93 0050
	Chrome	36 514 979-00 0050
	Brushed Platinum	36 514 979-06 0050
	Platinum	36 514 979-08 0050
	Dark Chrome	36 514 979-19 0050
	Light Gold	36 514 979-26 0050
	Brushed Light Gold	36 514 979-27 0050
	Brushed Durabronze (23kt Gold)	36 514 979-28 0050
	Matte Black	36 514 979-33 0050
	Brushed Bronze	36 514 979-42 0050
	Brushed Champagne (22kt Gold)	36 514 979-46 0050
	Champagne (22kt Gold)	36 514 979-47 0050
	Brushed Dark Platinum	36 514 979-99 0050

Recommended miscellaneous

- | | | |
|---|-------------------------------|---------------|
|  | Concealed wall elbow - | 35 085 970 90 |
| | • max. recess depth 163 mm | |
| | • min. recess depth 90 mm | |

36 514 979

mm [inches]

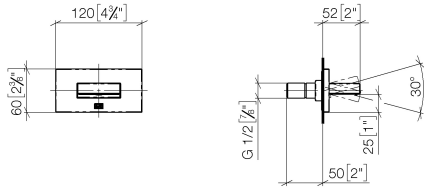

Flow rate chart



36 514 979

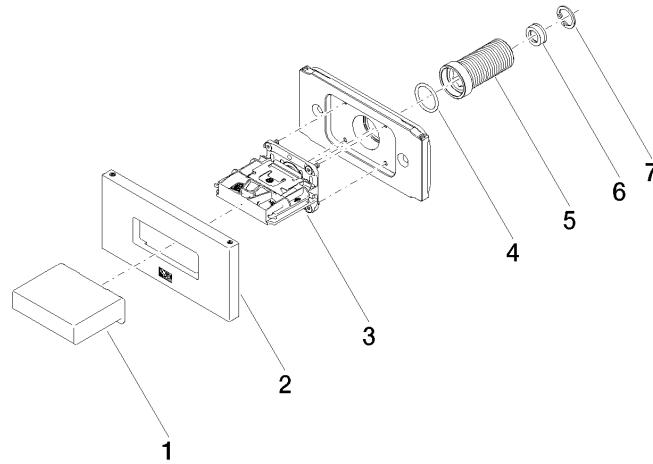

Spare parts list

No.	Item Number	Name	Quantity used	Delivery time
1	09 17 01 230-93	casing	1	20
2	90 27 97 041 00-93	rosette	1	20
3	90 29 03 088 00 90	insert	1	2
4	90 14 10 010 00 90	seal	1	2
5	09 24 04 336 90	nipple	1	2
6	09 23 01 165 90	flow reducer	1	2
7	09 16 01 014 90	ring	1	2