

Wall valve anti-clockwise closing hot 1/2" - Dark Chrome









CL.1

36 607 742



- without rosette
- handle Ø 60mm
- with hot marking
- head part with cut-to-length spindle and sleeve
- WRAS 2010066

Fits: CL.1, CYO

	Dark Chrome	36 607 742-19
	Chrome	36 607 742-00
	Brushed Platinum	36 607 742-06
	Brushed Durabronze (23kt Gold)	36 607 742-28
	Matte Black	36 607 742-33
	Brushed Champagne (22kt Gold)	36 607 742-46
	Champagne (22kt Gold)	36 607 742-47
	Brushed Dark Platinum	36 607 742-99

36 607 742

mm [inches]

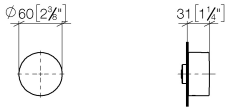

Certificates

LGA\_38107.

LGA\_29931.

WRAS\_2010066.

36 607 742

Parts for other finishes can be found here: [Chrome](#)

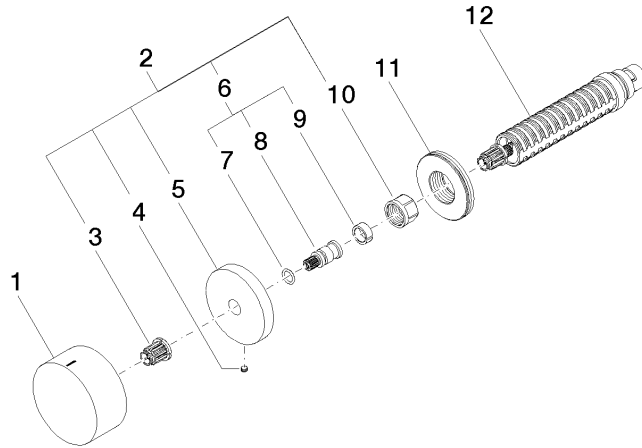

### Spare parts list

No.	Item Number	Name	Quantity used	Delivery time
1	09 20 74 021-19	handle ( hot )	1	60
2	04 27 74 004 00-19	rosette	1	20
3	90 12 12 002 00 90	fixing cap	1	2
4	09 31 11 055 90	pin	1	2
5	09 27 74 004-19	rosette	1	20
6	04 29 06 020 00-00	spindle	1	10
7	90 14 10 060 00 90	seal	1	2
8	09 29 06 020-19	spindle	1	-
Spare part can no longer be ordered, please order the replacement item				
9	90 14 15 020 03 90	ring	1	2
10	90 23 30 023 00 90	nut	1	2
11	09 30 01 107 90	sleeve	1	2
12	90 90 03 142 00 90	top	1	2