









36 608 980

- rosette 60 x 60 mm
- head part with cut-to-length spindle and sleeve



	Brushed Dark Platinum	36 608 980-99
	Chrome	36 608 980-00
	Brushed Platinum	36 608 980-06
	Platinum	36 608 980-08
	Dark Chrome	36 608 980-19
	Brushed Light Gold	36 608 980-27
	Brushed Durabronze (23kt Gold)	36 608 980-28
	Matte Black	36 608 980-33
	Brushed Chrome	36 608 980-93

Required miscellaneous

Wall valve 3/4" - 35 608 970 90



- max. recess depth 145 mm
- min. recess depth 75 mm

36 608 980

mm [inches]

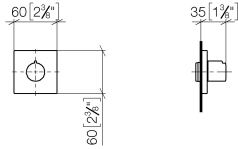

Certificates

IAPMO_4976 (2). WRAS_2010066.

36 608 980

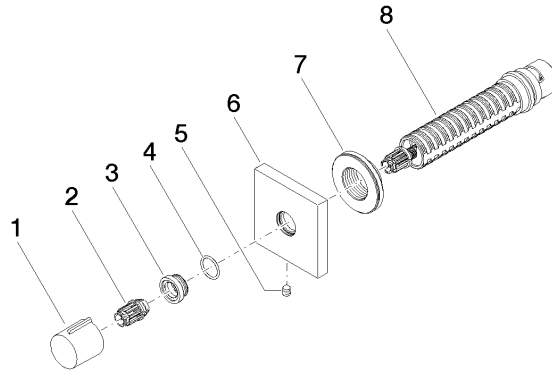

Spare parts list

No.	Item Number	Name	Quantity used	Delivery time
1	09 20 98 001-99	handle	1	30
2	09 12 12 005 90	fixing cap	1	2
3	09 12 12 043-99	base	1	30
4	09 14 10 017 90	seal	1	2
5	90 31 11 004 00 90	pin	1	2
6	09 27 98 014-99	rosette	1	30
7	09 21 02 151 90	sleeve	1	2
8	90 90 03 128 00 90	top	1	2