











36 608 985

- rosette 60 x 60 mm
- head part with cut-to-length spindle and sleeve



	Platinum	36 608 985-08
	Chrome	36 608 985-00
	Brushed Platinum	36 608 985-06
	Dark Chrome	36 608 985-19
	Brushed Light Gold	36 608 985-27
	Brushed Durabronze (23kt Gold)	36 608 985-28
	Matte Black	36 608 985-33
	Brushed Chrome	36 608 985-93
	Brushed Dark Platinum	36 608 985-99

**Required miscellaneous**

- |  |   |               |
|--|---|---------------|
|  | <b>Wall valve 3/4" -</b><br>•max. recess depth 145 mm<br>•min. recess depth 75 mm | 35 608 970 90 |
|--|---|---------------|

36 608 985

mm [inches]

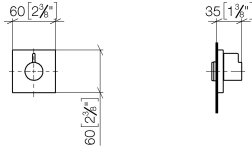

Certificates

IAPMO\_4976 (2). WRAS\_2010066.

36 608 985

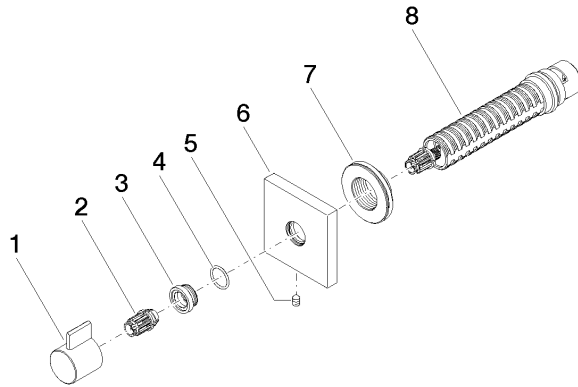

**Spare parts list**

No.	Item Number	Name	Quantity used	Delivery time
1	09 20 98 002-08	handle	1	40
2	09 12 12 005 90	fixing cap	1	2
3	09 12 12 043-08	base	1	40
4	09 14 10 017 90	seal	1	2
5	90 31 11 004 00 90	pin	1	2
6	09 27 98 014-08	rosette	1	40
7	09 21 02 151 90	sleeve	1	2
8	90 90 03 128 00 90	top	1	2