







CL.1 Wall valve clockwise closing 1/2" - Chrome

CL.1

36 627 705 Product version from 10/14/2020



- with CASCADE structure
- rosette 60 x 60 mm
- without marking
- head part with cut-to-length spindle and sleeve
- WRAS

	Chrome	36 627 705-00
	Brushed Platinum	36 627 705-06
	Dark Chrome	36 627 705-19
	Brushed Champagne (22kt Gold)	36 627 705-46
	Champagne (22kt Gold)	36 627 705-47
	Brushed Dark Platinum	36 627 705-99

Required miscellaneous



- Wall valve 1/2" -** 35 607 970 90
- max. recess depth mm
 - min. recess depth mm

36 627 705 Product version from 10/14/2020

mm [inches]



Codes & Standards

DIN 4109	EN 1111	EN 200	ISO 3822
Scottish Water Byelaws	UK Water Supply Regulations	Ü-Zeichen	

Certificates

DVGW_DW-6501DN0	WRAS_2011	LGA_29	WRAS_2010	DVGW_DW-6512DN0
LGA_29				

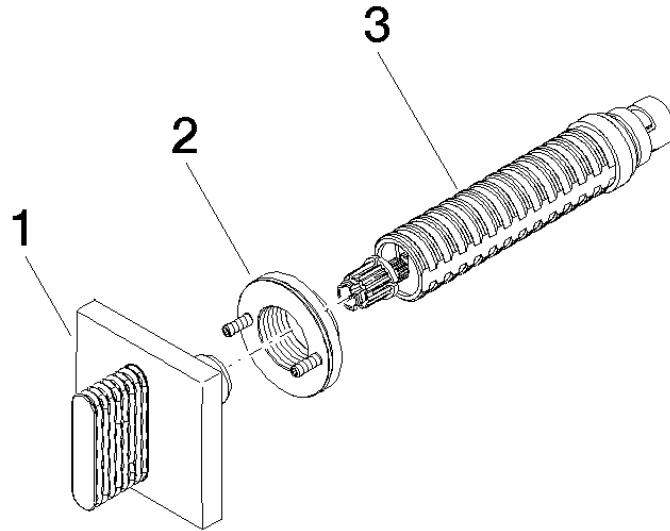

Spare parts list

No.	Item Number	Name	Quantity used	Delivery time
1	90 20 70 053 01-00	handle	1	10
2	90 21 02 108 00 90	disc	1	2
3	90 90 03 143 00 90	top	1	2