





CL.1 Wall valve clockwise closing cold 1/2" - Champagne (22kt Gold)

CL.1

36 627 706



- with CASCADE structure
- rosette 60 x 60 mm
- with cold marking
- head part with cut-to-length spindle and sleeve
- WRAS 2010066

	Champagne (22kt Gold)	36 627 706-47
	Chrome	36 627 706-00
	Brushed Platinum	36 627 706-06
	Dark Chrome	36 627 706-19
	Brushed Champagne (22kt Gold)	36 627 706-46
	Brushed Dark Platinum	36 627 706-99

Required miscellaneous

- Wall valve 1/2" -** 35 607 970 90
- max. recess depth 150 mm
 - min. recess depth 105 mm



36 627 706

mm [inches]

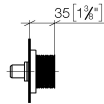
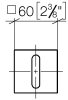

Certificates

LGA_29931.

WRAS_2010066.

36 627 706

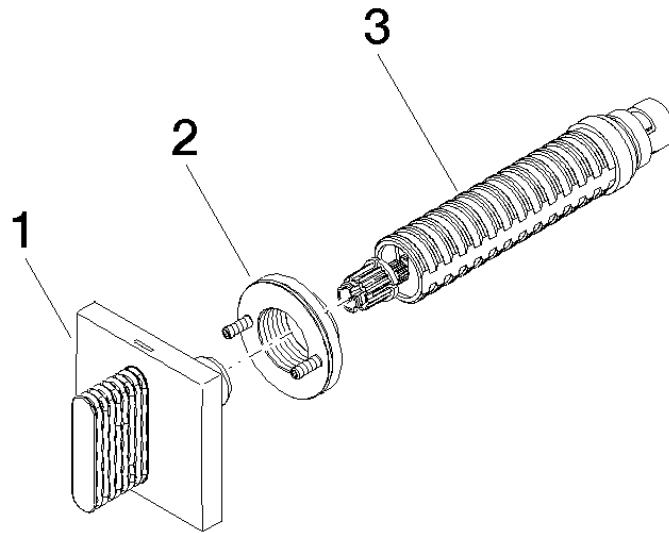

Spare parts list

No.	Item Number	Name	Quantity used	Delivery time
1	90 20 70 053 02-47	handle (cold)	1	30
2	90 21 02 108 00 90	disc	1	2
3	90 90 03 143 00 90	top	1	2