







CL.1 Wall valve anti-clockwise closing hot 1/2" - Brushed Dark Platinum

CL.1

36 627 707



- with CASCADE structure
- rosette 60 x 60 mm
- with hot marking
- head part with cut-to-length spindle and sleeve
- WRAS 2010066

	Brushed Dark Platinum	36 627 707-99
	Chrome	36 627 707-00
	Brushed Platinum	36 627 707-06
	Dark Chrome	36 627 707-19
	Brushed Champagne (22kt Gold)	36 627 707-46
	Champagne (22kt Gold)	36 627 707-47

Required miscellaneous



- Wall valve 1/2" -** 35 607 970 90
- max. recess depth 150 mm
 - min. recess depth 105 mm

36 627 707

mm [inches]

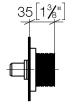

Certificates

DVGW_DW-
6501DN0116.

IAPMO_4976 (1).

LGA_29931.

WRAS_2010066.

LGA_29932.

36 627 707

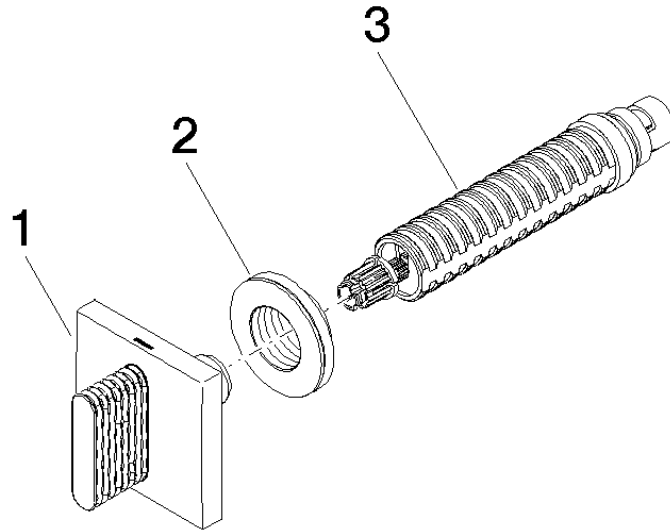

Spare parts list

No.	Item Number	Name	Quantity used	Delivery time
1	90 20 70 053 03-99	handle (hot)	1	30
2	09 21 02 108 90	disc	1	60
3	90 90 03 142 00 90	top	1	2