











83 060 892



- gauge 600 mm
- width 655mm
- height 55 mm
- rosette Ø 55 mm
- 81mm projection

Fits TARA

	Platinum	83 060 892-08
	Chrome	83 060 892-00
	Brushed Platinum	83 060 892-06
	Dark Chrome	83 060 892-19
	Brushed Durabronze (23kt Gold)	83 060 892-28
	Matte Black	83 060 892-33
	Brushed Champagne (22kt Gold)	83 060 892-46
	Champagne (22kt Gold)	83 060 892-47
	Brushed Chrome	83 060 892-93
	Brushed Dark Platinum	83 060 892-99

83 060 892

mm [inches]



83 060 892

Parts for other finishes can be found here: [Chrome](#)

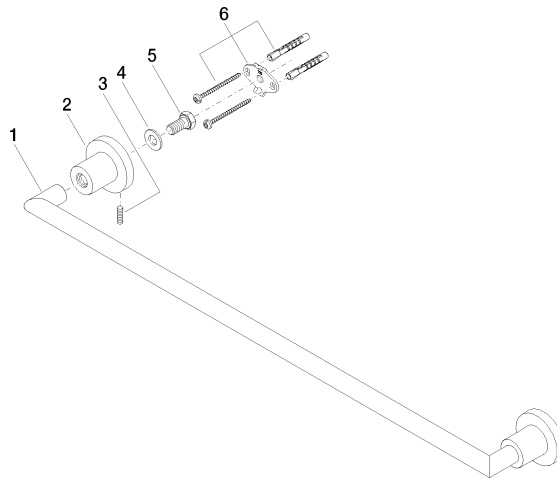

Spare parts list

No.	Item Number	Name	Quantity used	Delivery time
1	05 28 22 589 00-08	holder	1	40
2	08 17 89 505-08	holder	2	40
3	04 31 11 113 00 90	pin	2	2
4	09 30 11 046 90	disc	2	2
5	09 30 30 071 90	screw	2	2
6	05 17 20 739 00 90	fixing set	2	2